



LIG
CREATIVE

ITI
PROFESSIONAL

NG
TREND

2020
NEW CATALOG

Creative
Professional
Trend
Lighting Solution



skarlat.ua

LED

CRI 70+



CRI 80+



CRI 90+



ОБЛАСТЬ ПРИМЕНЕНИЯ

Офисы
Магазины

Частные дома
Офисы
Торговые площадки

Музеи
Галереи
Изысканные рестораны
Эксклюзивные товары
в магазинах

УСЛОВНЫЕ ОБОЗНАЧЕНИЯ



LED модуль



GU10

тип цоколя



заземление

220
240 V~ 50Hz

входное напряжение



используется в помещении



соответствует европейскому стандарту EN

IP

класс пылевлагозащиты



правильная утилизация



угол поворота



врезной светильник

Contents

01 Ceiling lights

02 Downlights

03 Pendant lights

04 Spotlights

05 Track lights

06 Wall lights

07 Floodlight

CEILING LIGHTS

стр 24-25



стр 26-27

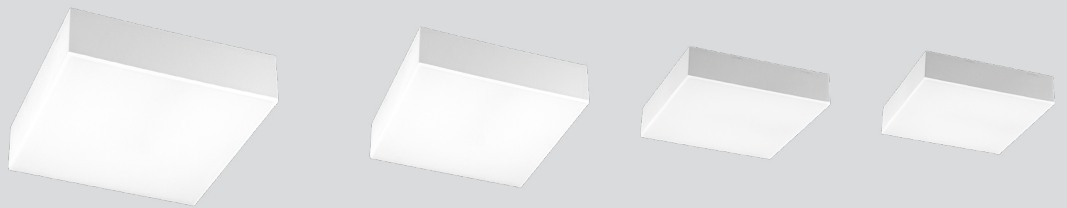

стр 20-21



стр 22-23



стр 30-31



стр 28-29





стр 32-33



стр 36-37

DOWNLIGHTS



стр 64-65

стр 74



стр 66-67

стр 75

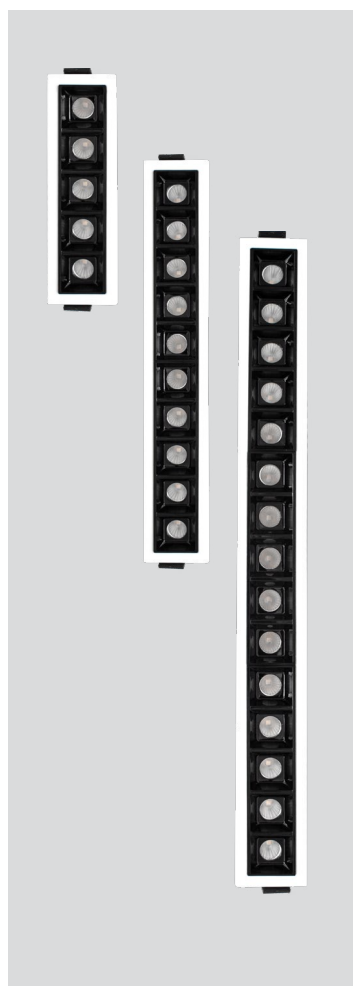

стр 90-91



стр 70

стр 71

стр 72

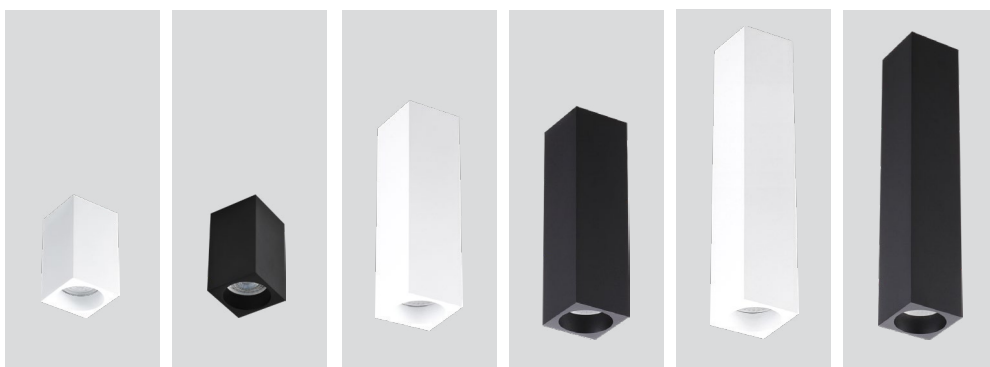

стр 76

стр 77

стр 78



стр 88-89

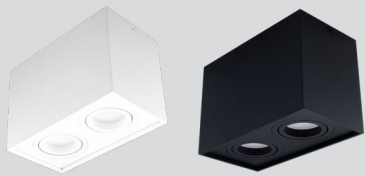

стр 82

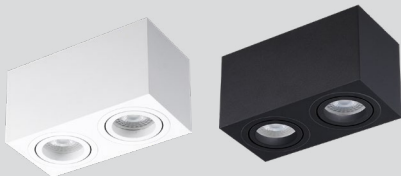

стр 83



стр 80



стр 81

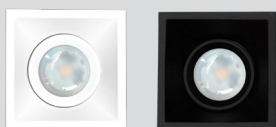

стр 56

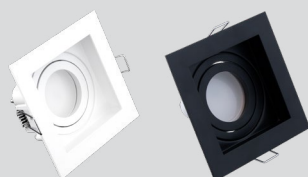

стр 57

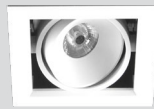

стр 84

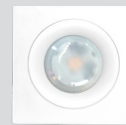

стр 58



стр 54



стр 55

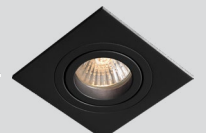

стр 86

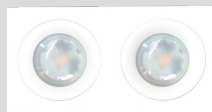

стр 58



стр 52-53



стр 62-63



стр 60-61



стр 50



стр 51



стр 42

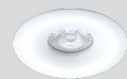

стр 43

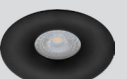

стр 48



стр 44



PENDANT LIGHTS



стр 94



стр 95



стр 96



стр 98



стр 99

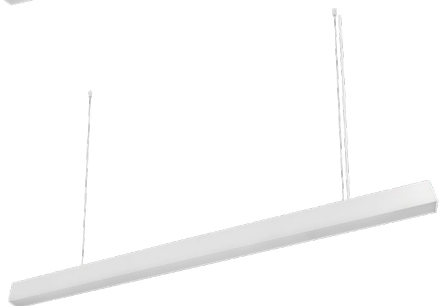
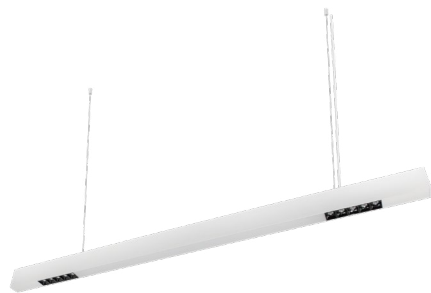
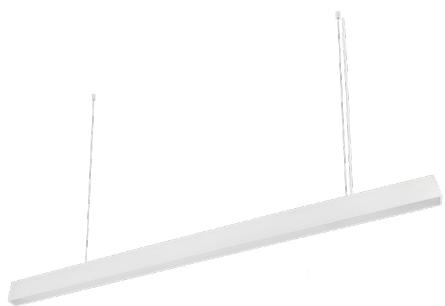

стр 100-101

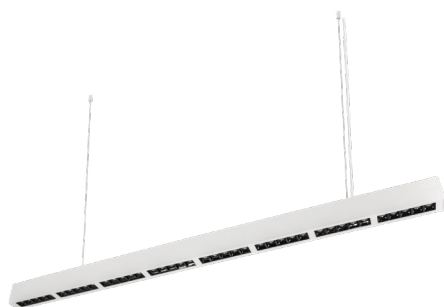
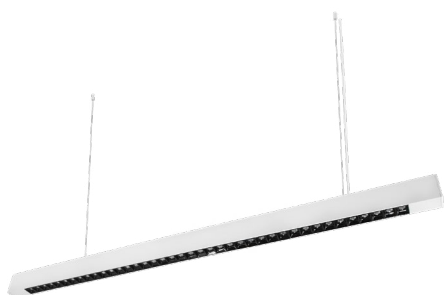

стр 102-103

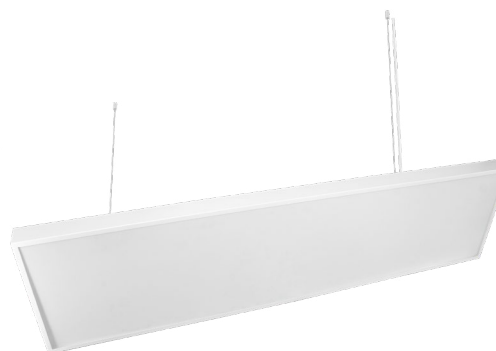
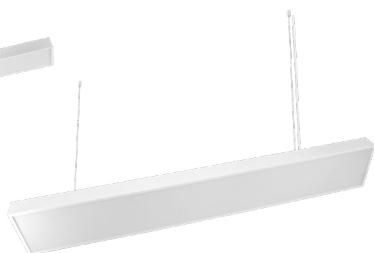
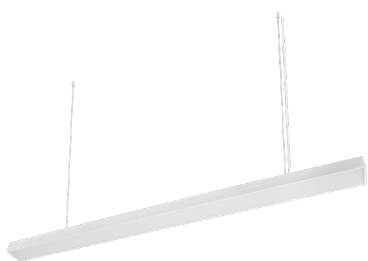

стр 104-105

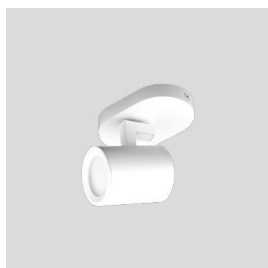

стр 116



стр 117



стр 110

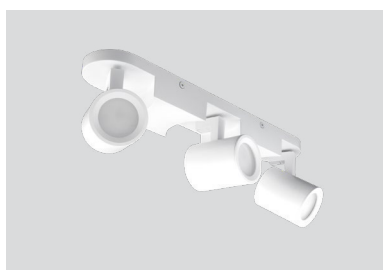

стр 118



стр 108

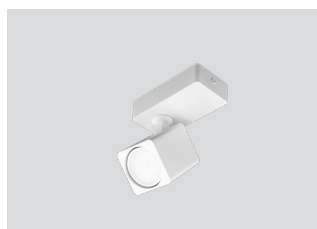

стр 120



стр 121





стр 111



стр 112



стр 114



стр 115

TRACK LIGHTS

стр 124-125

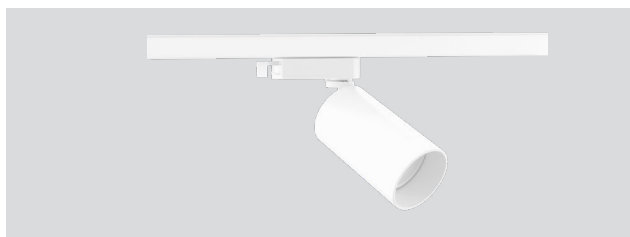
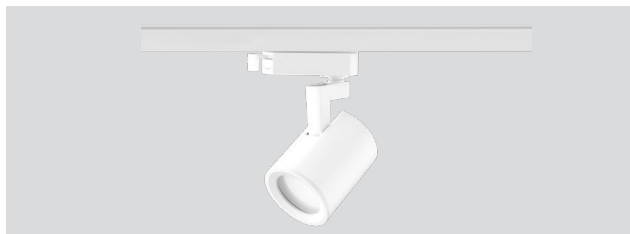

стр 128-129



стр 130-131

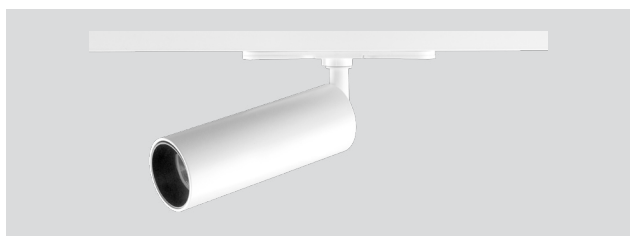

стр 132-133

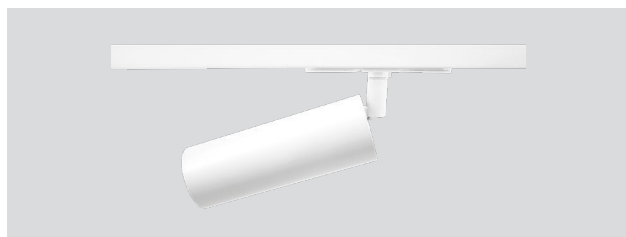

стр 134-135



стр 136-137

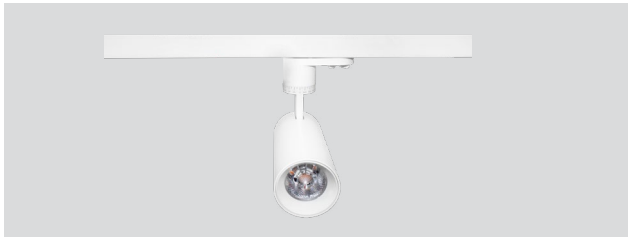

стр 138-139



стр 140-141

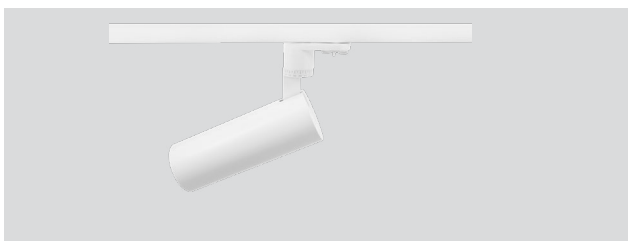

TRACK RINGS

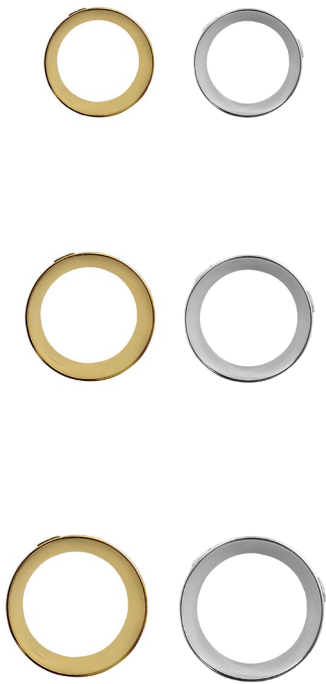

стр 144

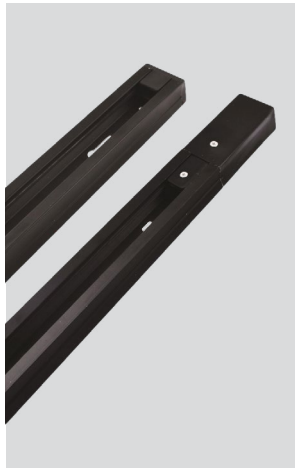
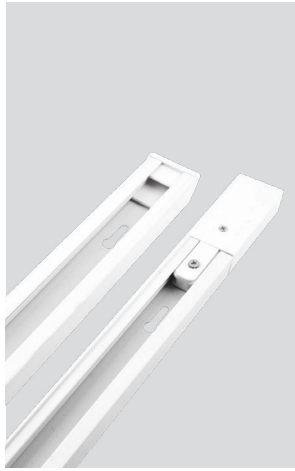

стр 142

TRACK PROFILE TRACK CONNECTORS



стр 143

CABLE SYSTEMS FOR HANGING TRACK



стр 143

WALL LIGHTS

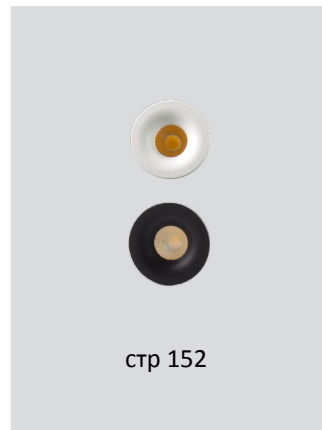

FLOODLIGHT



OUTDOOR LIGHTING



стр 156-157



стр 158-159



стр 160-161



стр 162



стр 163



стр 164-165



стр 166-167



НАКЛАДНЫЕ СВЕТИЛЬНИКИ

располагаются на потолке или стене. В основном, данный тип светильников используется в качестве основного источника света. Все представленные модели гармонично впишутся в любой интерьер .

• **Ceiling lights**
series



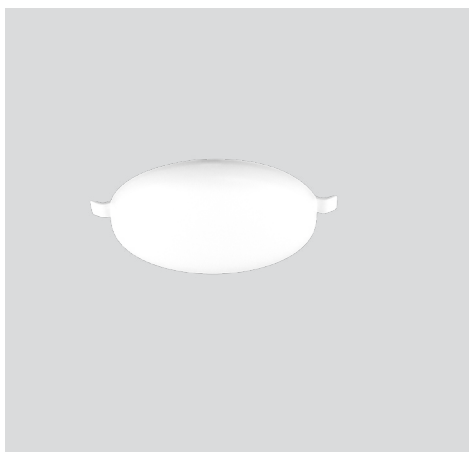

PC0005-32Q RD 5W



Series	Ceiling lights
LED	SMD 2835
CCT	6000K
CRI	RA ≥ 70
Power	5w
Luminous Flux	450 Lm
Beam Angle	120°
Color	White
Material	Plastic
Size	D 70 x H 25

118,00 грн.

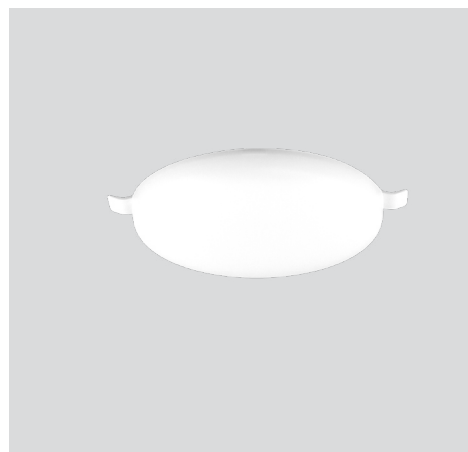

PC0007-32Q RD 7W



Series	Ceiling lights
LED	SMD 2835
CCT	6000K
CRI	RA ≥ 70
Power	7w
Luminous Flux	630 Lm
Beam Angle	120°
Color	White
Material	Plastic
Size	D 110 x H 35

177,00 грн.

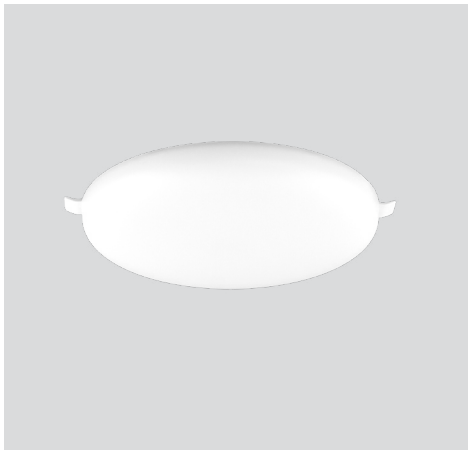

PC0012-32Q RD 12W 

Series	Ceiling lights
LED	SMD 2835
CCT	6000K
CRI	RA ≥ 70
Power	12w
Luminous Flux	1080 Lm
Beam Angle	120°
Color	White
Material	Plastic
Size	D 155 x H 35

274,00 грн.

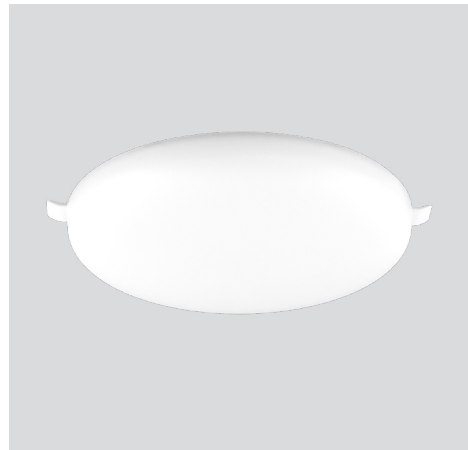

PC0018-32Q RD 18W 

Series	Ceiling lights
LED	SMD 2835
CCT	6000K
CRI	RA ≥ 70
Power	18w
Luminous Flux	1620 Lm
Beam Angle	120°
Color	White
Material	Plastic
Size	D 190 x H 35

354,00 грн.

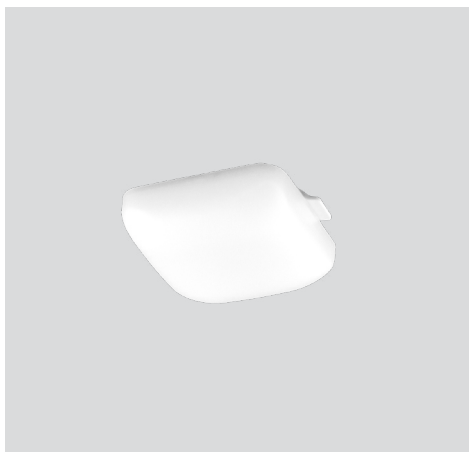

PC0005-32Q SQ 5W



Series	Ceiling lights
LED	SMD 2835
CCT	6000K
CRI	RA ≥ 70
Power	5w
Luminous Flux	450 Lm
Beam Angle	120°
Color	White
Material	Plastic
Size	L 70 x W 70 x H 25

118,00 грн.

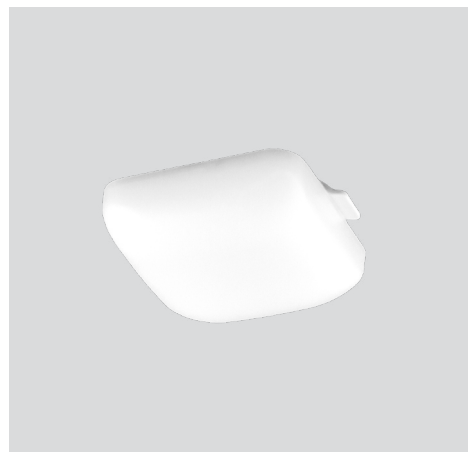



PC0007-32Q SQ 7W

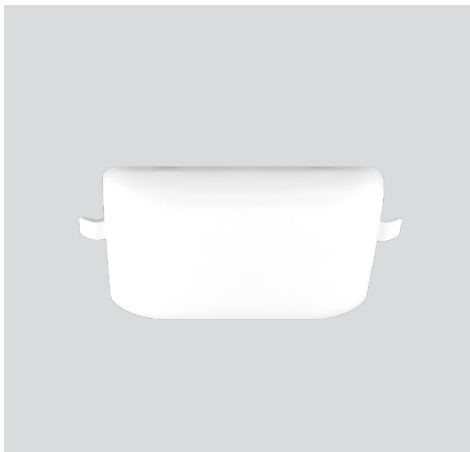

Series	Ceiling lights
LED	SMD 2835
CCT	6000K
CRI	RA ≥ 70
Power	7w
Luminous Flux	630 Lm
Beam Angle	120°
Color	White
Material	Plastic
Size	L 110 x W 110 x H 35

177,00 грн.



PC0012-32Q SQ 12W 

Series	Ceiling lights
LED	SMD 2835
CCT	6000K
CRI	RA ≥ 70
Power	12w
Luminous Flux	1080 Lm
Beam Angle	120 °
Color	White
Material	Plastic
Size	L 155 x W 155 x H 35

274,00 грн.



PC0018-32Q SQ 18W 

Series	Ceiling lights
LED	SMD 2835
CCT	6000K
CRI	RA ≥ 70
Power	18w
Luminous Flux	1620 Lm
Beam Angle	120 °
Color	White
Material	Plastic
Size	L 190 x W 190 x H 35

354,00 грн.

PC0006-32HSF RD 6W



Series	Ceiling lights
LED	SMD 2835
CCT	6000K
CRI	RA ≥ 70
Power	6w
Luminous Flux	480 Lm
Beam Angle	120 °
Color	White
Material	Plastic
Size	D 91 x H 27



162,00 грн.

PC0012-32HSF RD 12W



Series	Ceiling lights
LED	SMD 2835
CCT	6000K
CRI	RA ≥ 70
Power	12w
Luminous Flux	960 Lm
Beam Angle	120 °
Color	White
Material	Plastic
Size	D 120 x H 27



214,00 грн.

PC0018-32HSF RD 18W

Series	Ceiling lights
LED	SMD 2835
CCT	6000K
CRI	RA ≥ 70
Power	18w
Luminous Flux	1440 Lm
Beam Angle	120 °
Color	White
Material	Plastic
Size	D156 x H 27



324,00 грн.

PC0024-32HSF RD 24W

Series	Ceiling lights
LED	SMD 2835
CCT	6000K
CRI	RA ≥ 70
Power	24w
Luminous Flux	1920 Lm
Beam Angle	120 °
Color	White
Material	Plastic
Size	D 190 x H 27



413,00 грн.

PC0006-32HSF SQ 6W



Series	Ceiling lights
LED	SMD 2835
CCT	6000K
CRI	RA ≥ 70
Power	6w
Luminous Flux	480 Lm
Beam Angle	120 °
Color	White
Material	Plastic
Size	L 90 x W 90 x H 27



162,00 грн.

PC0012-32HSF SQ 12W



Series	Ceiling lights
LED	SMD 2835
CCT	6000K
CRI	RA ≥ 70
Power	12w
Luminous Flux	960 Lm
Beam Angle	120 °
Color	White
Material	Plastic
Size	L 120 x W 120 x H 27



214,00 грн.

PC0018-32HSF SQ 18W

Series	Ceiling lights
LED	SMD 2835
CCT	6000K
CRI	RA ≥ 70
Power	18w
Luminous Flux	1440 Lm
Beam Angle	120 °
Color	White
Material	Plastic
Size	L 156 x W 156 x H 27



324,00 грн.

PC0024-32HSF SQ 24W

Series	Ceiling lights
LED	SMD 2835
CCT	6000K
CRI	RA ≥ 70
Power	24w
Luminous Flux	1920 Lm
Beam Angle	120 °
Color	White
Material	Plastic
Size	L 190 x W 190 x H 27



413,00 грн.



PC0006-14 RD 6W



Series	Ceiling lights
LED	SMD 2835
CCT	6000K
CRI	RA ≥ 80
Power	6w
Luminous Flux	400 Lm
Beam Angle	120 °
Color	White
Material	Aluminum
Size	D 120 x H 18



PC0012-14 RD 12W



Series	Ceiling lights
LED	SMD 2835
CCT	6000K
CRI	RA ≥ 80
Power	12w
Luminous Flux	840 Lm
Beam Angle	120 °
Color	White
Material	Aluminum
Size	D 172 x H 18



PC0018-14 RD 18W



Series	Ceiling lights
LED	SMD 2835
CCT	6000K
CRI	RA ≥ 80
Power	18w
Luminous Flux	1350 Lm
Beam Angle	120 °
Color	White
Material	Aluminum
Size	D 225 x H 18





PC0006-14 SQ 6W



Series	Ceiling lights
LED	SMD 2835
CCT	6000K
CRI	RA ≥ 80
Power	6w
Luminous Flux	400 Lm
Beam Angle	120 °
Color	White
Material	Aluminum
Size	L 120 x W 120 x H 20



PC0012-14 SQ 12W



Series	Ceiling lights
LED	SMD 2835
CCT	6000K
CRI	RA ≥ 80
Power	12w
Luminous Flux	840 Lm
Beam Angle	120 °
Color	White
Material	Aluminum
Size	L 172 x W 172 x H 20



PC0018-14 SQ 18W



Series	Ceiling lights
LED	SMD 2835
CCT	6000K
CRI	RA ≥ 80
Power	18w
Luminous Flux	1350 Lm
Beam Angle	120 °
Color	White
Material	Aluminum
Size	L 225 x W 225 x H 20





203,00 грн.

D519A-LED 5W WH



Series	Ceiling lights
LED	SMD 2835
CCT	3000K/4000K
CRI	RA ≥ 80
Power	5w
Luminous Flux	450 Lm
Beam Angle	90 °
Color	White
Material	Aluminum
Size	D 82 x H 80



278,00 грн.

D519B-LED 7W WH



Series	Ceiling lights
LED	SMD 2835
CCT	3000K/4000K
CRI	RA ≥ 80
Power	7w
Luminous Flux	630 Lm
Beam Angle	90 °
Color	White
Material	Aluminum
Size	D 95 x H 80



399,00 грн.

D519C-LED 12W WH



Series	Ceiling lights
LED	SMD 2835
CCT	3000K/4000K
CRI	RA ≥ 80
Power	12w
Luminous Flux	1080 Lm
Beam Angle	90 °
Color	White
Material	Aluminum
Size	D 128 x H 90



481,00 грн.

D519D-LED 18W WH



Series	Ceiling lights
LED	SMD 2835
CCT	3000K/4000K
CRI	RA ≥ 80
Power	18w
Luminous Flux	1620 Lm
Beam Angle	90°
Color	White
Material	Aluminum
Size	D 147 x H 105



692,00 грн.

D519E-LED 24W WH



Series	Ceiling lights
LED	SMD 2835
CCT	3000K/4000K
CRI	RA ≥ 80
Power	24w
Luminous Flux	2160 Lm
Beam Angle	90°
Color	White
Material	Aluminum
Size	D 175 x H 105



1008,00 грн.

D519F-LED 30W WH



Series	Ceiling lights
LED	SMD 2835
CCT	3000K/4000K
CRI	RA ≥ 80
Power	30w
Luminous Flux	2700 Lm
Beam Angle	90°
Color	White
Material	Aluminum
Size	D 220 x H 110







203,00 грн.

D519A-LED 5W BK



Series	Ceiling lights
LED	SMD 2835
CCT	3000K/4000K
CRI	RA ≥ 80
Power	5w
Luminous Flux	450 Lm
Beam Angle	90 °
Color	Black
Material	Aluminum
Size	D 82 x H 80



278,00 грн.

D519B-LED 7W BK



Series	Ceiling lights
LED	SMD 2835
CCT	3000K/4000K
CRI	RA ≥ 80
Power	7w
Luminous Flux	630 Lm
Beam Angle	90 °
Color	Black
Material	Aluminum
Size	D 95 x H 80



399,00 грн.

D519C-LED 12W BK



Series	Ceiling lights
LED	SMD 2835
CCT	3000K/4000K
CRI	RA ≥ 80
Power	12w
Luminous Flux	1080 Lm
Beam Angle	90 °
Color	Black
Material	Aluminum
Size	D 128 x H 90



481,00 грн.



692,00 грн.



1008,00 грн.

D519D-LED 18W BK



Series	Ceiling lights
LED	SMD 2835
CCT	3000K/4000K
CRI	RA ≥ 80
Power	18w
Luminous Flux	1620 Lm
Beam Angle	90°
Color	Black
Material	Aluminum
Size	D 147 x H 105

D519E-LED 24W BK



Series	Ceiling lights
LED	SMD 2835
CCT	3000K/4000K
CRI	RA ≥ 80
Power	24w
Luminous Flux	2160 Lm
Beam Angle	90°
Color	Black
Material	Aluminum
Size	D 175 x H 105

D519F-LED 30W BK



Series	Ceiling lights
LED	SMD 2835
CCT	3000K/4000K
CRI	RA ≥ 80
Power	30w
Luminous Flux	2700 Lm
Beam Angle	90°
Color	Black
Material	Aluminum
Size	D 220 x H 110







ТОЧЕЧНЫЕ СВЕТИЛЬНИКИ

это безусловный лидер среди наиболее популярных решений для создания проектов освещения. Применяются как в качестве второстепенных акцентов в помещении, так и основных источников света. Серия наполнена разнообразными моделями, которые отличаются современным дизайном и исполнением.

- **Downlights**
series





133,00 грн.

TH3913 WH GU10



Series	Downlight
Lamp	GU10 MAX 50W
Color	White
Material	Aluminum
Size	D 90 x H 42



133,00 грн.

TH3913 BK GU10



Series	Downlight
Lamp	GU10 MAX 50W
Color	Black
Material	Aluminum
Size	D 90 x H 42



TH3911 WH GU10



Series	Downlight
Lamp	GU10 MAX 50W
Color	White
Material	Aluminum
Size	D 98 x H 25

125,00 грн.

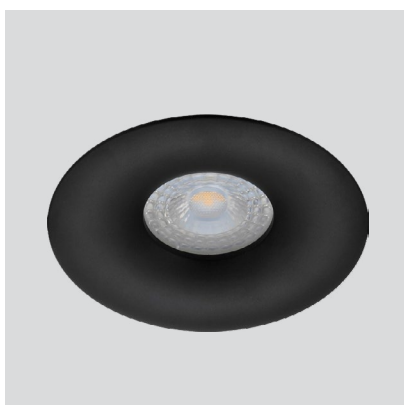

TH3911 BK GU10



Series	Downlight
Lamp	GU10 MAX 50W
Color	Black
Material	Aluminum
Size	D 98 x H 25

125,00 грн.

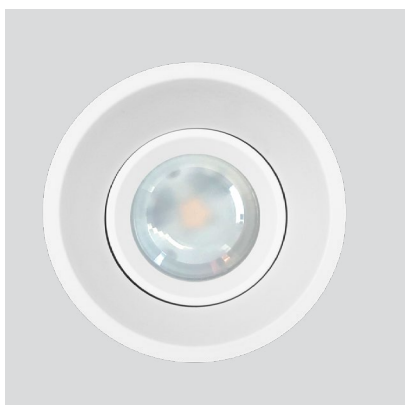

162,00 грн.

AK-219A WH GU10



Series	Downlight
Lamp	GU10 MAX 50W
Color	White
Material	Aluminum
Size	D 92 x H 42



162,00 грн.

AK-219A BK GU10



Series	Downlight
Lamp	GU10 MAX 50W
Color	Black
Material	Aluminum
Size	D 92 x H 42







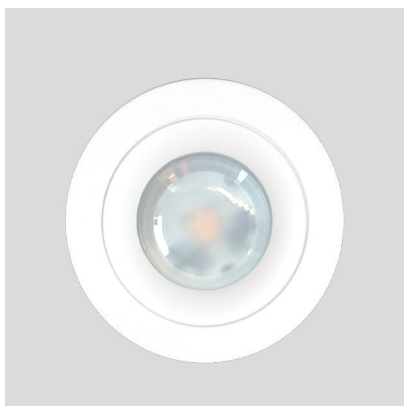

162,00 грн.

AK-747E WH GU10



Series	Downlight
Lamp	GU10 MAX 50W
Color	White
Material	Aluminum
Size	D 94 x H 23

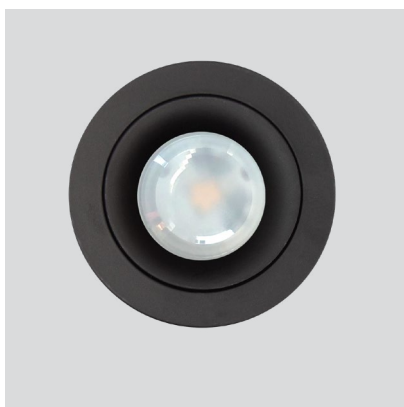

162,00 грн.

AK-747E BK GU10



Series	Downlight
Lamp	GU10 MAX 50W
Color	Black
Material	Aluminum
Size	D 94 x H 23





206,00 грн.

TH3529 WH GU10



Series	Downlight
Lamp	GU10 MAX 50W
Color	White
Material	Aluminum
Size	D 100 x H 30



206,00 грн.

TH3529 BK GU10



Series	Downlight
Lamp	GU10 MAX 50W
Color	Black
Material	Aluminum
Size	D 100 x H 30



TH5808 WH GU10



Series	Downlight
Lamp	GU10 MAX 50W
Color	White
Material	Aluminum
Size	D 92 x H 25

177,00 грн.



TH5808 BK GU10



Series	Downlight
Lamp	GU10 MAX 50W
Color	Black
Material	Aluminum
Size	D 92 x H 25

177,00 грн.



413,00 грн.

TH5812 WH 2xGU10



Series	Downlight
Lamp	GU10 MAX 50W
Color	White
Material	Aluminum
Size	L 173 x D 89 x H 24



413,00 грн.

TH5812 BK 2xGU10



Series	Downlight
Lamp	GU10 MAX 50W
Color	Black
Material	Aluminum
Size	L 173 x D 89 x H 24





133,00 грн.

TH3912 WH GU10



Series	Downlight
Lamp	GU10 MAX 50W
Color	White
Material	Aluminum
Size	L 98 x W 98 x H 27



133,00 грн.

TH3912 BK GU10



Series	Downlight
Lamp	GU10 MAX 50W
Color	Black
Material	Aluminum
Size	L 98 x W 98 x H 27



TH5809 WH GU10



Series	Downlight
Lamp	GU10 MAX 50W
Color	White
Material	Aluminum
Size	L 92 x W 92 x H 25

184,00 грн.



TH5809 BK GU10



Series	Downlight
Lamp	GU10 MAX 50W
Color	Black
Material	Aluminum
Size	L 92 x W 92 x H 25

184,00 грн.



174,00 грн.

AK-220A WH GU10



Series	Downlight
Lamp	GU10 MAX 50W
Color	White
Material	Aluminum
Size	L 90 x W 90 x H 42

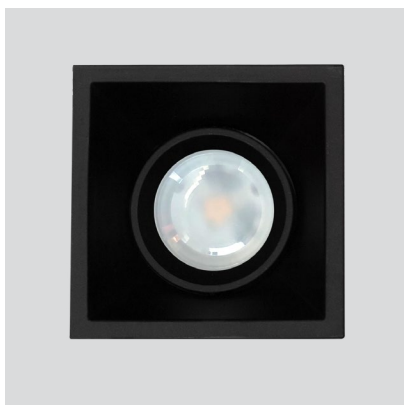

174,00 грн.

AK-220A BK GU10



Series	Downlight
Lamp	GU10 MAX 50W
Color	Black
Material	Aluminum
Size	L 90 x W 90 x H 42



214,00 грн.

TH 3530 WH GU10



Series	Downlight
Lamp	GU10 MAX 50W
Color	White
Material	Aluminum
Size	L 100 x W 100 x H 30

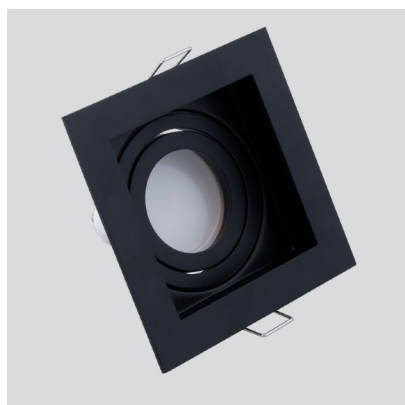

214,00 грн.

TH 3530 BK GU10



Series	Downlight
Lamp	GU10 MAX 50W
Color	Black
Material	Aluminum
Size	L 100 x W 100 x H 30

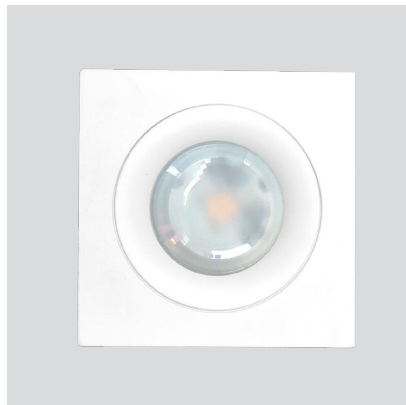

AK-748E-1 WH GU10

Series	Downlight
Lamp	GU10 MAX 50W
Color	White
Material	Aluminum
Size	L 92 x W 92 x H 23

170,00 грн.

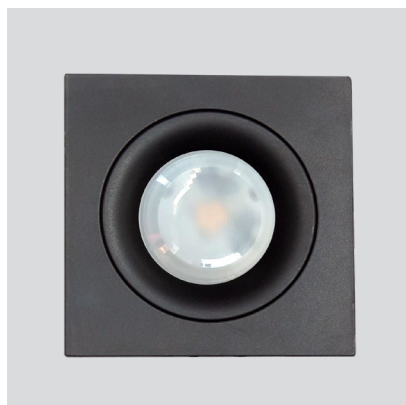

AK-748E-1 BK GU10

Series	Downlight
Lamp	GU10 MAX 50W
Color	Black
Material	Aluminum
Size	L 92 x W 92 x H 23

170,00 грн.

AK-748E-2 WH 2XGU10

Series	Downlight
Lamp	GU10 MAX 50W
Color	White
Material	Aluminum
Size	L 178 x W 92 x H 23

324,00 грн.



AK-748E-2 BK 2XGU10

Series	Downlight
Lamp	GU10 MAX 50W
Color	Black
Material	Aluminum
Size	L 178 x W 92 x H 23

324,00 грн.





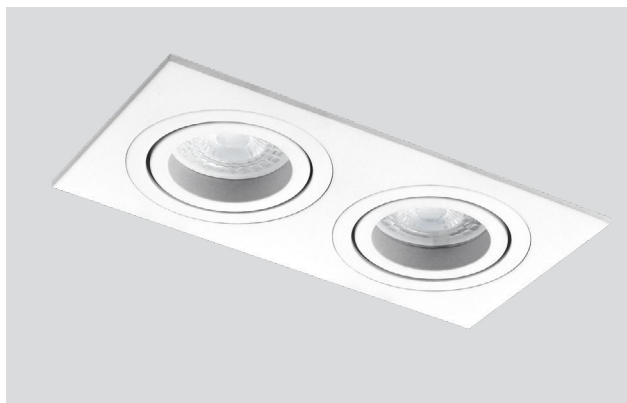

413,00 грн.

TH5813 WH 2XGU10



Series	Downlight
Lamp	GU10 MAX 50W
Color	White
Material	Aluminum
Size	L 174 x W 90 x H 25



413,00 грн.

TH5813 BK 2XGU10



Series	Downlight
Lamp	GU10 MAX 50W
Color	Black
Material	Aluminum
Size	L 174 x W 90 x H 25

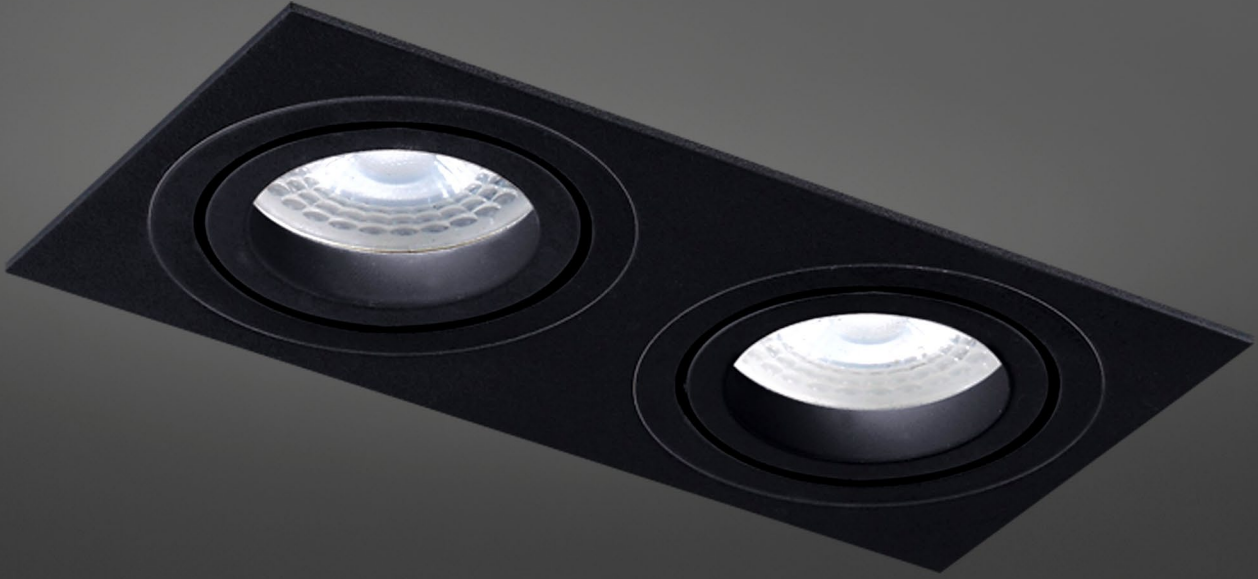



442,00 грн.

TH3532 WH 2XGU10



Series	Downlight
Lamp	GU10 MAX 50W
Color	White
Material	Aluminum
Size	L 185 x W 100 x H 30

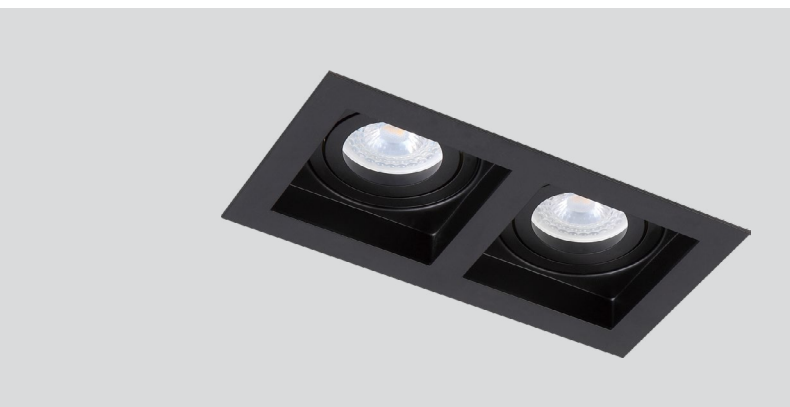

TH3532 BK 2XGU10



Series	Downlight
Lamp	GU10 MAX 50W
Color	Black
Material	Aluminum
Size	L 185 x W 100 x H 30

442,00 грн.



TH5829 WH GU10



Series	Tube Downlight
Lamp	GU10 MAX 50W
Color	White
Material	Aluminum
Size	D 65 x H 100

324,00 грн.



TH5829 BK GU10



Series	Tube Downlight
Lamp	GU10 MAX 50W
Color	Black
Material	Aluminum
Size	D 65 x H 100

324,00 грн.

TH5832 WH GU10



Series	Tube Downlight
Lamp	GU10 MAX 50W
Color	White
Material	Aluminum
Size	D 80 x H 105

398,00 грн.



TH5832 BK GU10



Series	Tube Downlight
Lamp	GU10 MAX 50W
Color	Black
Material	Aluminum
Size	D 80 x H 105

398,00 грн.





TH5827 WH GU10

Series	Tube Downlight
Lamp	GU10 MAX 50W
Color	White
Material	Aluminum
Size	D 80 x H 85



398,00 грн.

TH5827 BK GU10

Series	Tube Downlight
Lamp	GU10 MAX 50W
Color	Black
Material	Aluminum
Size	D 80 x H 85



398,00 грн.



TH5801 WH GU10



Series	Tube Downlight
Lamp	GU10 MAX 50W
Color	White
Material	Aluminum
Size	D 96 x H 125

413,00 ГРН.



TH5801 BK GU10



Series	Tube Downlight
Lamp	GU10 MAX 50W
Color	Black
Material	Aluminum
Size	D 96 x H 125

413,00 ГРН.





TH6802-200 WH GU10

Series	Tube Downlight
Lamp	GU10 MAX 50W
Color	White
Material	Aluminum
Size	D 70 x H 200

442,00 грн.

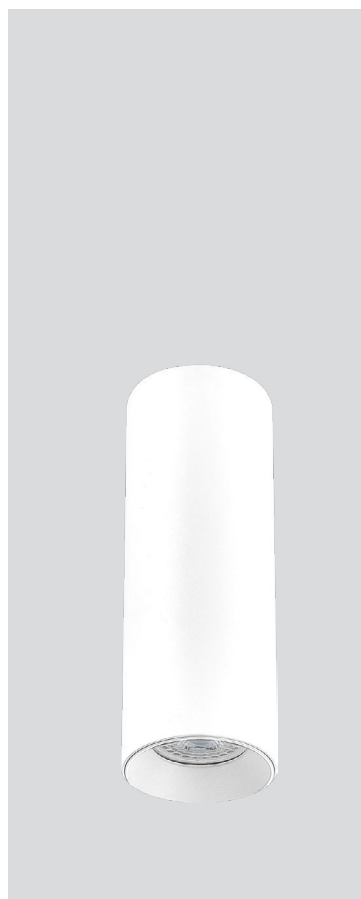

TH6802-200 BK GU10

Series	Tube Downlight
Lamp	GU10 MAX 50W
Color	Black
Material	Aluminum
Size	D 70 x H 200

442,00 грн.

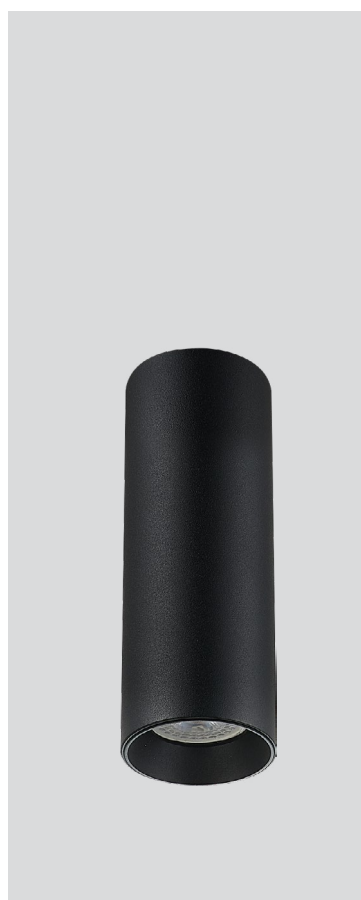

TH6802-300 WH GU10



Series	Tube Downlight
Lamp	GU10 MAX 50W
Color	White
Material	Aluminum
Size	D 70 x H 300

545,00 грн.

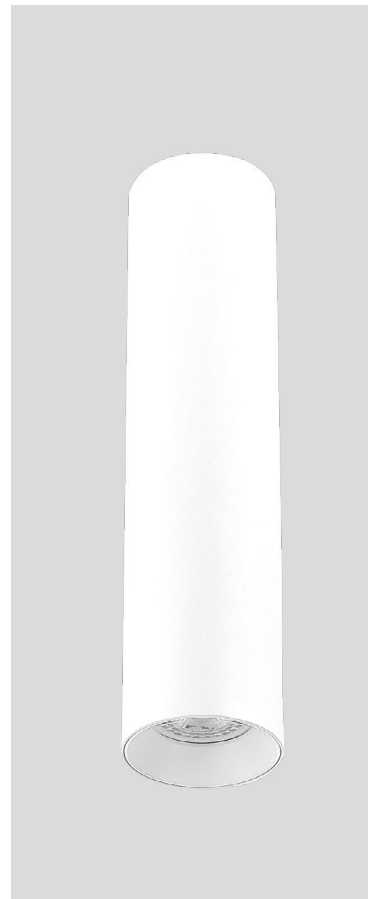

TH6802-300 BK GU10



Series	Tube Downlight
Lamp	GU10 MAX 50W
Color	Black
Material	Aluminum
Size	D 70 x H 300

545,00 грн.

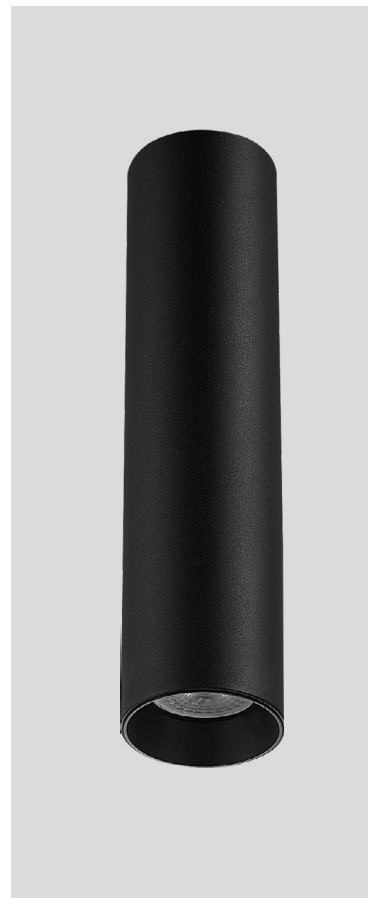

TH6802-400 WH GU10

Series	Tube Downlight
Lamp	GU10 MAX 50W
Color	White
Material	Aluminum
Size	D 70 x H 400

634,00 грн.

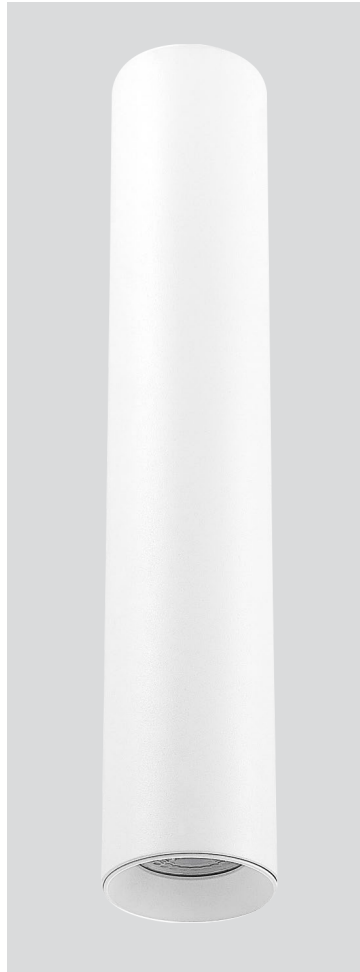

TH6802-400 BK GU10

Series	Tube Downlight
Lamp	GU10 MAX 50W
Color	Black
Material	Aluminum
Size	D 70 x H 400

634,00 грн.







450,00 грн.

TH5802 WH GU10

Series	Tube Downlight
Lamp	GU10 MAX 50W
Color	White
Material	Aluminum
Size	L 97 x W 97 x H 125

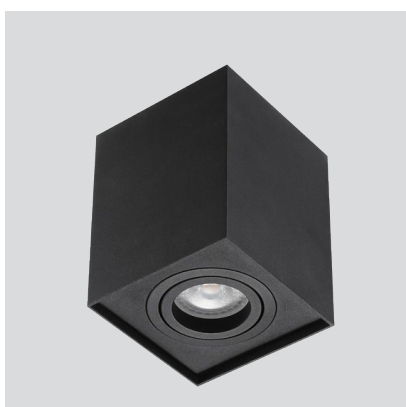

450,00 грн.

TH5802 BK GU10

Series	Tube Downlight
Lamp	GU10 MAX 50W
Color	Black
Material	Aluminum
Size	L 97 x W 97 x H 125



TH5828 WH GU10



Series	Tube Downlight
Lamp	GU10 MAX 50W
Color	White
Material	Aluminum
Size	L 80 x W 80 x H 85

442,00 грн.



TH5828 BK GU10



Series	Tube Downlight
Lamp	GU10 MAX 50W
Color	Black
Material	Aluminum
Size	L 80 x W 80 x H 85

442,00 грн.



310,00 грн.

TH6803-100 WH GU10



Series	Tube Downlight
Lamp	GU10 MAX 50W
Color	White
Material	Aluminum
Size	L 56 x W 56 x H 100



310,00 грн.

TH6803-100 BK GU10



Series	Tube Downlight
Lamp	GU10 MAX 50W
Color	Black
Material	Aluminum
Size	L 56 x W 56 x H 100

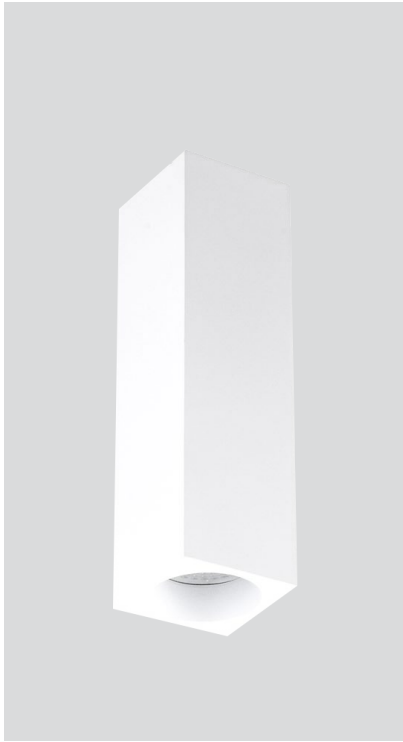

TH6803-200 WH GU10



Series	Tube Downlight
Lamp	GU10 MAX 50W
Color	White
Material	Aluminum
Size	L 56 x W 56 x H 200

457,00 грн.



TH6803-200 BK GU10



Series	Tube Downlight
Lamp	GU10 MAX 50W
Color	Black
Material	Aluminum
Size	L 56 x W 56 x H 200

457,00 грн.

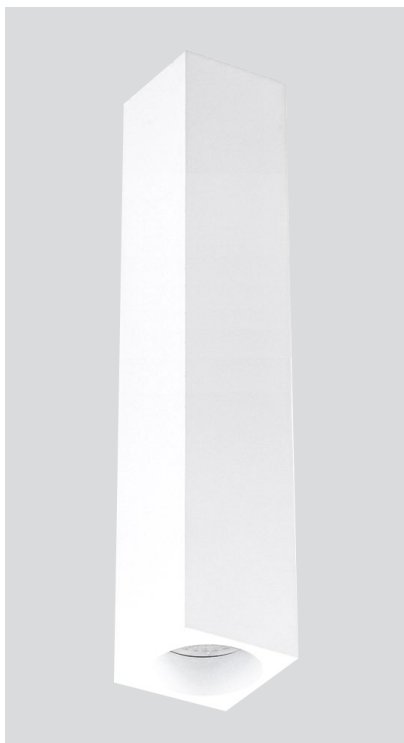

TH6803-300 WH GU10



Series	Tube Downlight
Lamp	GU10 MAX 50W
Color	White
Material	Aluminum
Size	L 56 x W 56 x H 300

605,00 грн.

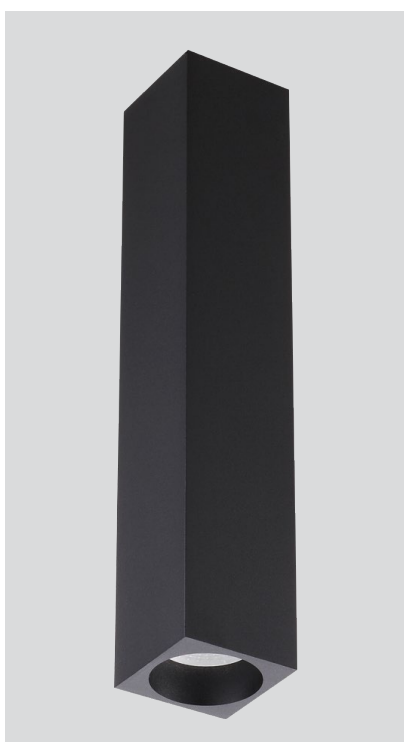

TH6803-300 BK GU10



Series	Tube Downlight
Lamp	GU10 MAX 50W
Color	Black
Material	Aluminum
Size	L 56 x W 56 x H 300

605,00 грн.



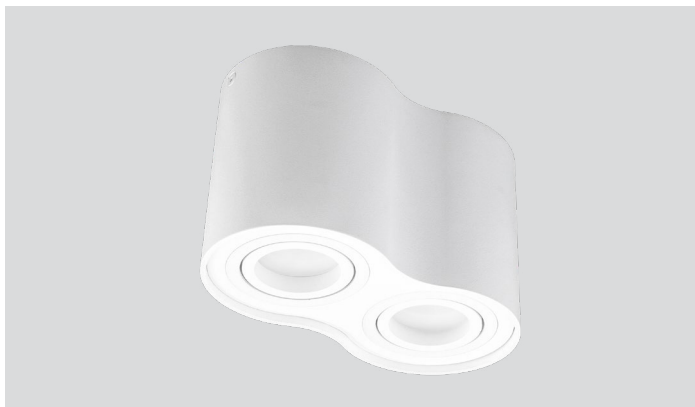

TH5803 WH 2XGU10



Series	Tube Downlight
Lamp	GU10 MAX 50W
Color	White
Material	Aluminum
Size	L 178 x D 96 x H 125

899,00 грн.



TH5803 BK 2XGU10



Series	Tube Downlight
Lamp	GU10 MAX 50W
Color	Black
Material	Aluminum
Size	L 178 x D 96 x H 125

899,00 грн.

DOWNLIGHTS



767,00 грн.

TH5834 WH 2XGU10



Series	Tube Downlight
Lamp	GU10 MAX 50W
Color	White
Material	Aluminum
Size	L 160 x D 80 x H 85



767,00 грн.

TH5834 BK 2XGU10



Series	Tube Downlight
Lamp	GU10 MAX 50W
Color	Black
Material	Aluminum
Size	L 160 x D 80 x H 85



936,00 грн.

TH5804 WH 2XGU10



Series	Tube Downlight
Lamp	GU10 MAX 50W
Color	White
Material	Aluminum
Size	L 181 x W 96 x H 125



936,00 грн.

TH5804 BK 2XGU10



Series	Tube Downlight
Lamp	GU10 MAX 50W
Color	Black
Material	Aluminum
Size	L 181 x W 96 x H 125

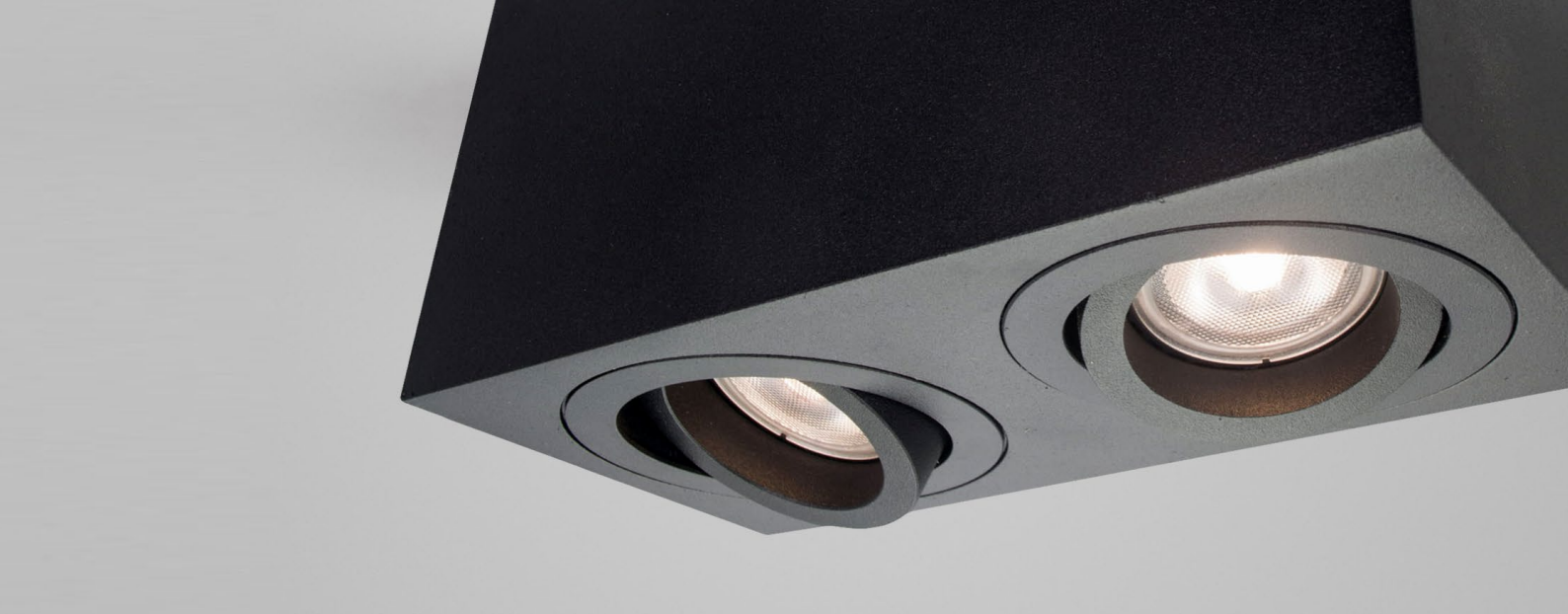

TH5835 WH 2XGU10



Series	Tube Downlight
Lamp	GU10 MAX 50W
Color	White
Material	Aluminum
Size	L 160 x W 80 x H 85

848,00 грн.



TH5835 BK 2XGU10



Series	Tube Downlight
Lamp	GU10 MAX 50W
Color	Black
Material	Aluminum
Size	L 160 x W 80 x H 85

848,00 грн.

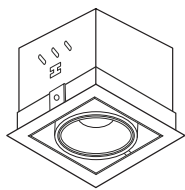

BX07-1-LED 7W WH



Series	Downlight
LED	COB
CCT	3000K/4000K
CRI	RA ≥ 80
Power	7w
Luminous Flux	525 Lm
Beam Angle	24 °
Color	White
Material	Aluminum
Size	L 122 x W 122 x H 70



443,00 грн.

BX07-1-LED 7W BK



Series	Downlight
LED	COB
CCT	3000K/4000K
CRI	RA ≥ 80
Power	7w
Luminous Flux	525 Lm
Beam Angle	24 °
Color	Black
Material	Aluminum
Size	L 122 x W 122 x H 70



443,00 грн.



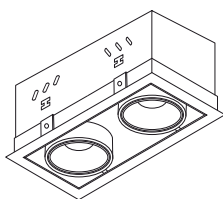

BX07-2-LED 2x7W WH



Series	Downlight
LED	COB
CCT	3000K/4000K
CRI	RA ≥ 80
Power	7w
Luminous Flux	2 x 525 Lm
Beam Angle	24°
Color	White
Material	Aluminum
Size	L 225 x W 122 x H 70

885,00 грн.

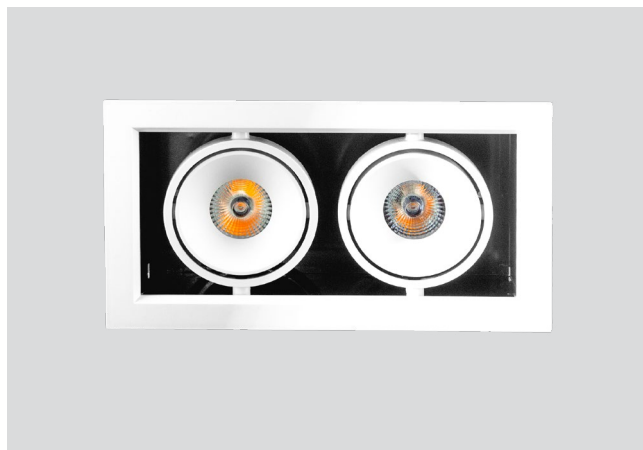

BX07-2-LED 2x7W BK



Series	Downlight
LED	COB
CCT	3000K/4000K
CRI	RA ≥ 80
Power	7w
Luminous Flux	2 x 525 Lm
Beam Angle	24°
Color	Black
Material	Aluminum
Size	L 225 x W 122 x H 70

885,00 грн.





XT4550-1-LED 1,5w WH

Series	Downlight
LED	COB
CCT	3000K/6000K
CRI	RA ≥ 80
Power	1,5w
Luminous Flux	120 Lm
Beam Angle	24 °
Color	White
Material	Aluminum
Size	L 45 x W 45 x H 48

436,00 грн.

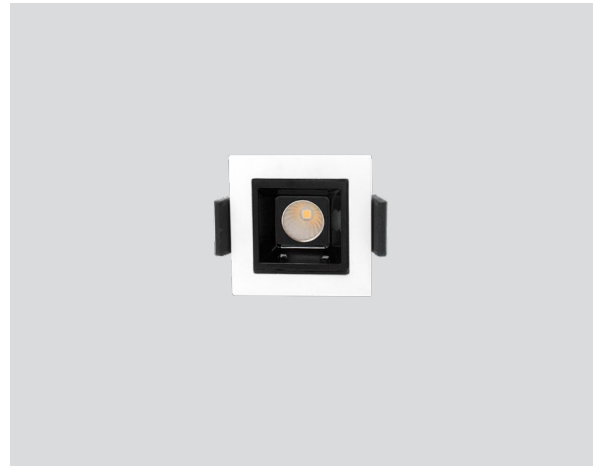
**XT4550-2-LED 3w WH**

Series	Downlight
LED	COB
CCT	3000K/6000K
CRI	RA ≥ 80
Power	3w
Luminous Flux	240 Lm
Beam Angle	24 °
Color	White
Material	Aluminum
Size	L 75 x W 45 x H 48

571,00 грн.

**XT4550-3-LED 5w WH**

Series	Downlight
LED	COB
CCT	3000K/6000K
CRI	RA ≥ 80
Power	5w
Luminous Flux	400 Lm
Beam Angle	24 °
Color	White
Material	Aluminum
Size	L 105 x W 45 x H 48

752,00 грн.





XT4550-5-LED 8w WH

Series	Downlight
LED	COB
CCT	3000K/6000K
CRI	RA ≥ 80
Power	8w
Luminous Flux	640 Lm
Beam Angle	24 °
Color	White
Material	Aluminum
Size	L 145 x W 45 x H 48

865,00 грн.

XT4550-10-LED 12w WH

Series	Downlight
LED	COB
CCT	3000K/6000K
CRI	RA ≥ 80
Power	12w
Luminous Flux	960 Lm
Beam Angle	24 °
Color	White
Material	Aluminum
Size	L 280 x W 45 x H 48

1383,00 грн.

XT4550-15-LED 18w WH

Series	Downlight
LED	COB
CCT	3000K/6000K
CRI	RA ≥ 80
Power	18w
Luminous Flux	1440 Lm
Beam Angle	24 °
Color	White
Material	Aluminum
Size	L 413 x W 45 x H 48

1895,00 грн.

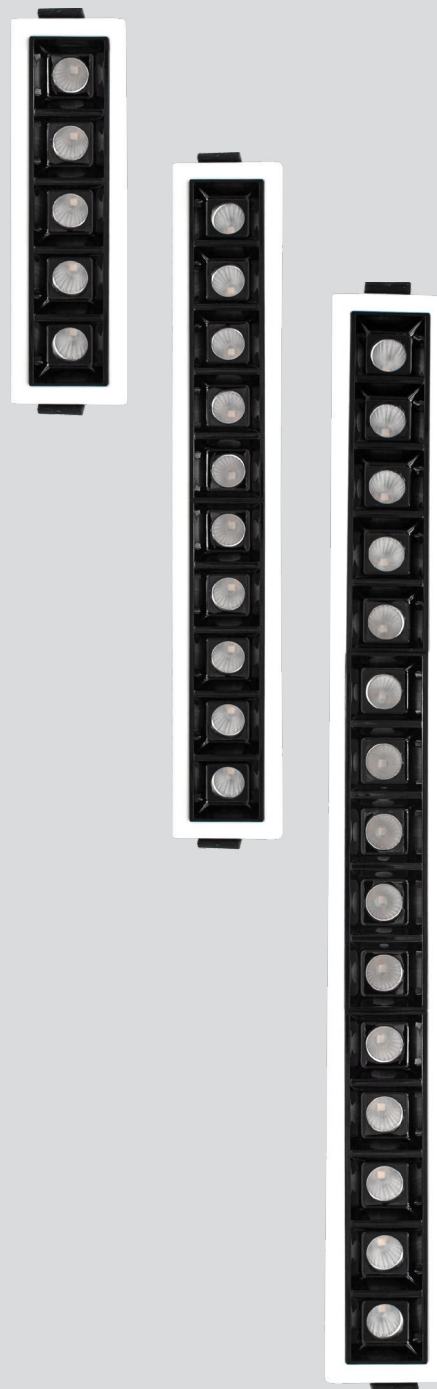





ПОДВЕСНЫЕ СВЕТИЛЬНИКИ

отличное решение, которое можно использовать как основное либо акцентное освещения. Серия светильников такого типа создана для применения в сфере интерьерной подсветки жилых и торговых помещений, выставочных залов, ресторанов, кафе, галерей и тд.

• **Pendant lights**
series



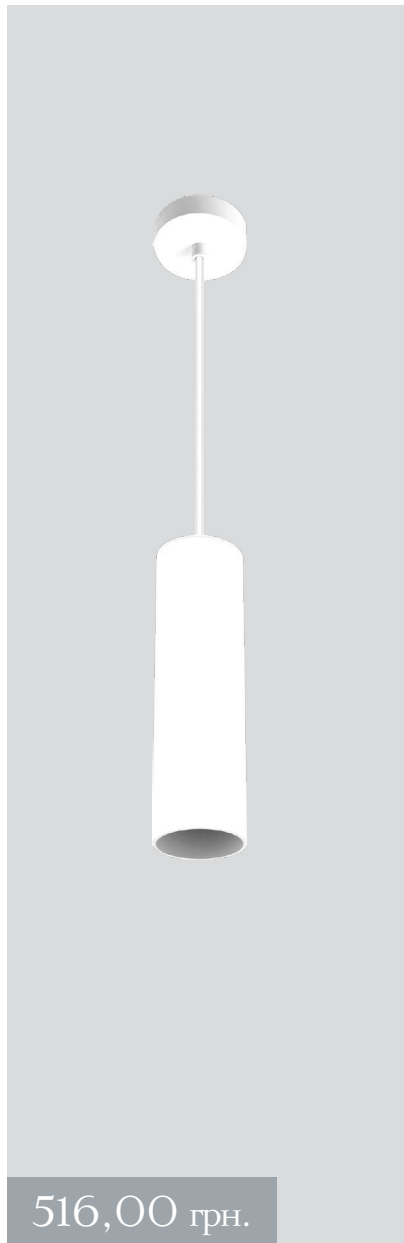

516,00 грн.

PD6801-200 WH GU10



Series	Pendant lights
Lamp	GU10 MAX 50W
Color	White
Material	Aluminum
Size	D 56 x H1 200 x H 1340



516,00 грн.

PD6801-200 BK GU10



Series	Pendant lights
Lamp	GU10 MAX 50W
Color	Black
Material	Aluminum
Size	D 56 x H1 200 x H 1340

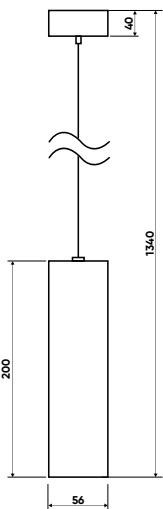

PD6801-300 WH GU10



Series	Pendant lights
Lamp	GU10 MAX 50W
Color	White
Material	Aluminum
Size	D 56 x H1 300 x H 1440

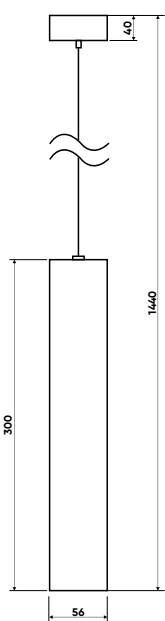
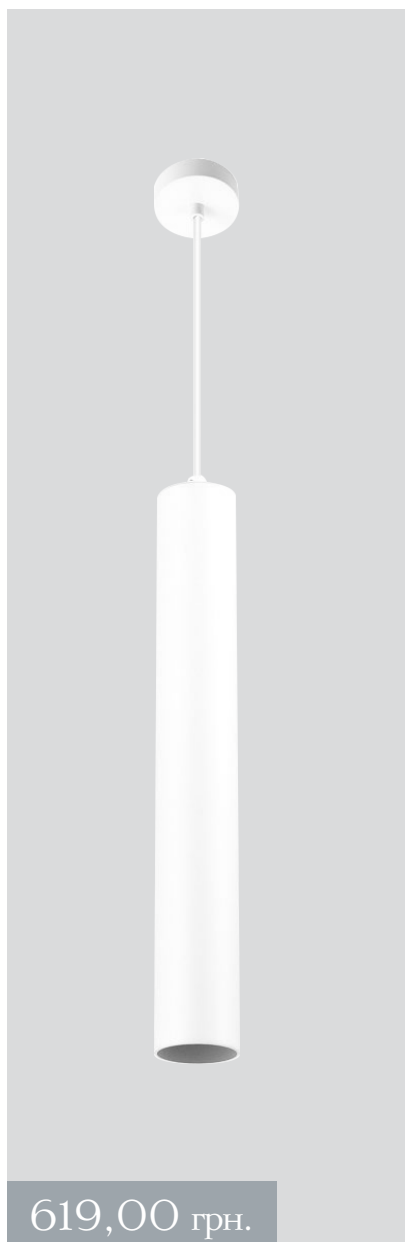

PD6801-300 BK GU10



Series	Pendant lights
Lamp	GU10 MAX 50W
Color	Black
Material	Aluminum
Size	D 56 x H1 300 x H 1440



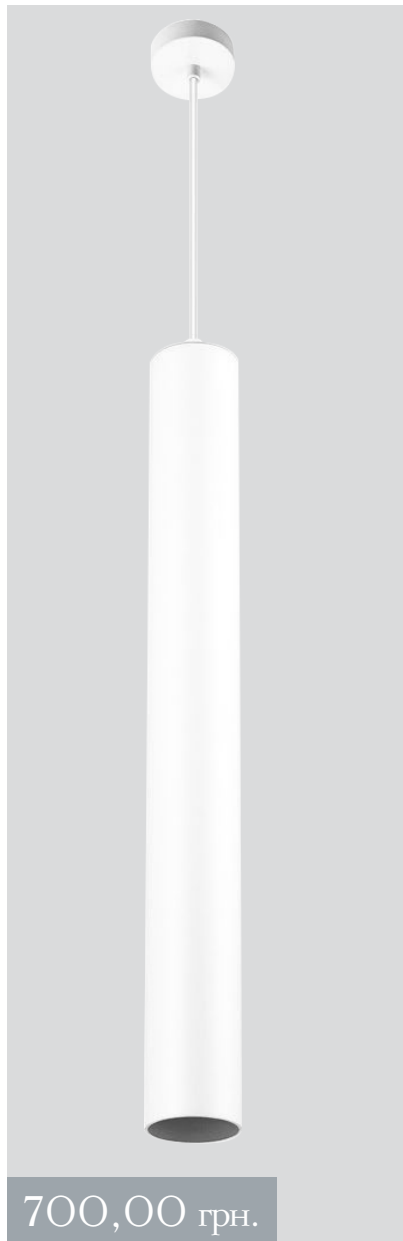
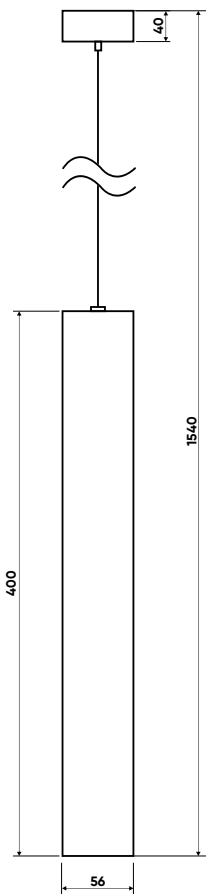

700,00 грн.

PD6801-400 WH GU10



Series	Pendant lights
Lamp	GU10 MAX 50W
Color	White
Material	Aluminum
Size	D 56 x H 400

PD6801-400 BK GU10



Series	Pendant lights
Lamp	GU10 MAX 50W
Color	Black
Material	Aluminum
Size	D 56 x H1 400 x H 1540



700,00 грн.



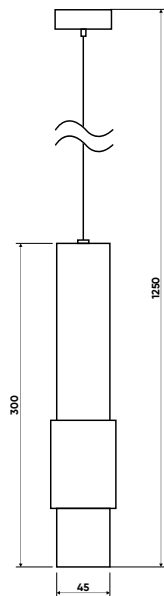

DX523A-COB 7w WH 

Series	Pendant lights
LED	COB
CCT	3000K/4000K
CRI	RA ≥ 80
Power	7w
Luminous Flux	500 Lm
Beam Angle	24 °
Color	White
Material	Aluminum
Size	D 45 x H1 300 x H 1250

DX523A-COB 7w BK 

Series	Pendant lights
LED	COB
CCT	3000K/4000K
CRI	RA ≥ 80
Power	7w
Luminous Flux	500 Lm
Beam Angle	24 °
Color	Black
Material	Aluminum
Size	D 45 x H1 300 x H 1250

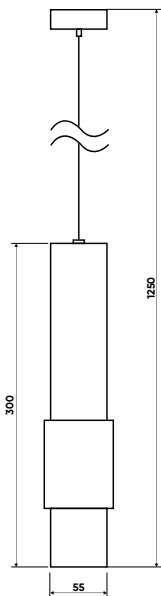

DX523B-COB 7w WH

Series	Pendant lights
LED	COB
CCT	3000K/4000K
CRI	RA ≥ 80
Power	7w
Luminous Flux	500 Lm
Beam Angle	24 °
Color	White
Material	Aluminum
Size	D 55 x H1 300 x H 1250

DX523B-COB 7w BK

Series	Pendant lights
LED	COB
CCT	3000K/4000K
CRI	RA ≥ 80
Power	7w
Luminous Flux	500 Lm
Beam Angle	24 °
Color	Black
Material	Aluminum
Size	D 55 x H1 300 x H 1250



XT3312A-LED 30W WH



Series	Pendant lights
LED	COB
CCT	3000K/ 4000K
CRI	RA ≥ 80
Power	30w
Luminous Flux	2400 Lm
Beam Angle	170 °
Color	White
Material	Aluminum
Size	L 1200 x W 34 x H1 67 x H 1000

1609,00 грн.

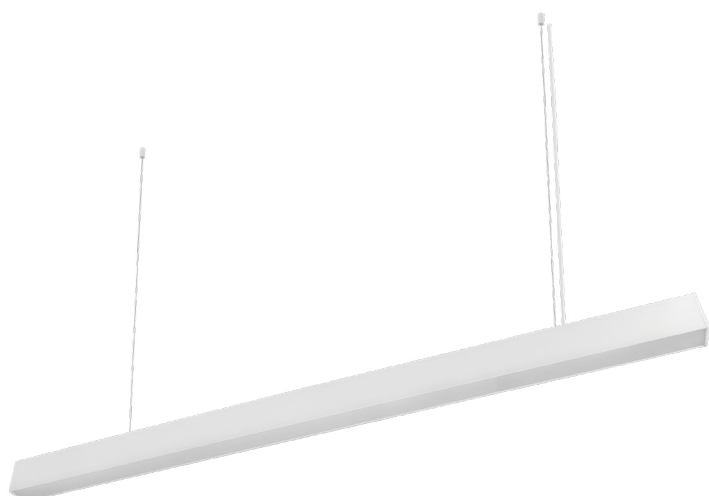

XT4312A-LED 40W WH



Series	Pendant lights
LED	COB
CCT	3000K/ 4000K
CRI	RA ≥ 80
Power	40w
Luminous Flux	2400 Lm
Beam Angle	170 °
Color	White
Material	Aluminum
Size	L 1200 x W 44 x H1 67 x H 1000

1789,00 грн.





XT3312B-LED 40W WH



Series	Pendant lights
LED	COB
CCT	3000K/ 4000K
CRI	RA ≥ 80
Power	40w
Luminous Flux	3200 Lm
Beam Angle	170 ° + 15/30 °
Color	White
Material	Aluminum
Size	L 1200 x W 34 x H1 67 x H 1000

2135,00 грн.



XT4312B-LED 40W WH



Series	Pendant lights
LED	COB
CCT	3000K/ 4000K
CRI	RA ≥ 80
Power	40w
Luminous Flux	3200 Lm
Beam Angle	170 ° + 15/30 °
Color	White
Material	Aluminum
Size	L 1200 x W 44 x H1 67 x H 1000

2376,00 грн.

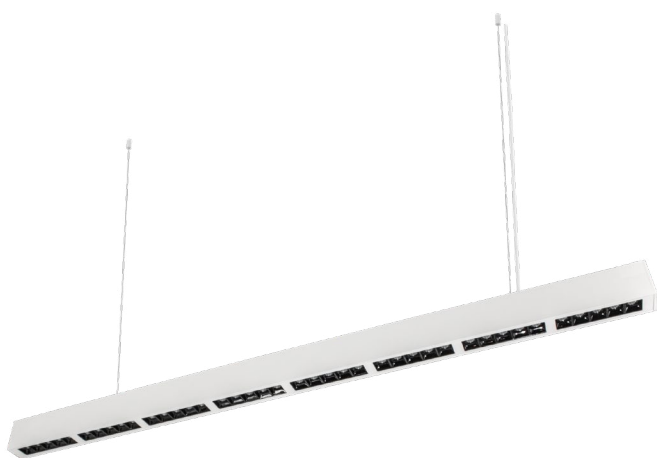
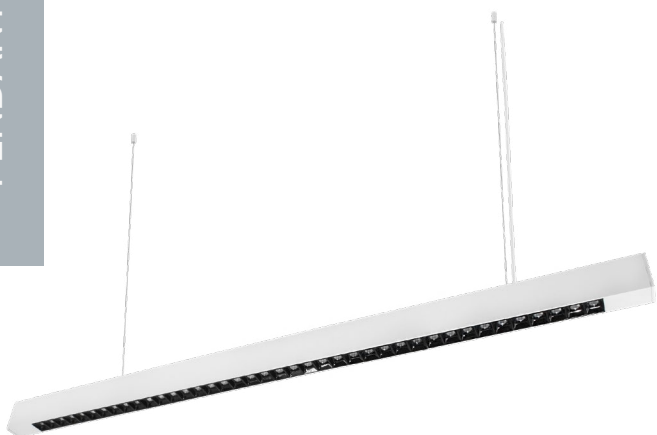

XT3312C-LED 40W WH



Series	Pendant lights
LED	COB
CCT	3000K/ 4000K
CRI	RA ≥ 80
Power	40w
Luminous Flux	3200 Lm
Beam Angle	170 °
Color	White
Material	Aluminum
Size	L 1200 x W 34 x H1 67 x H 1000

3158,00 грн.

XT4312C-LED 40W WH



Series	Pendant lights
LED	COB
CCT	3000K/ 4000K
CRI	RA ≥ 80
Power	40w
Luminous Flux	3200 Lm
Beam Angle	170 °
Color	White
Material	Aluminum
Size	L 1200 x W 44 x H1 67 x H 1000

3474,00 грн.

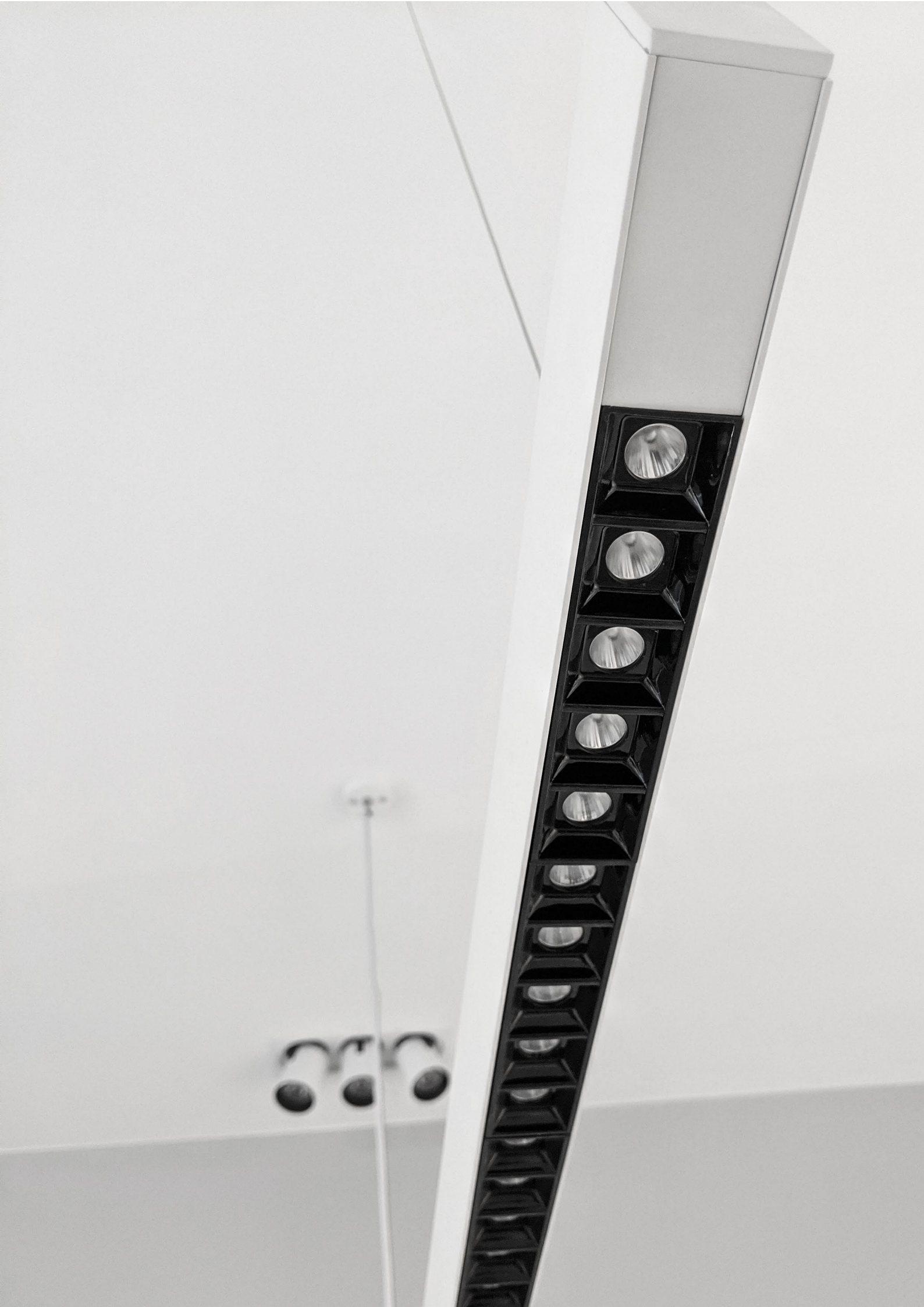

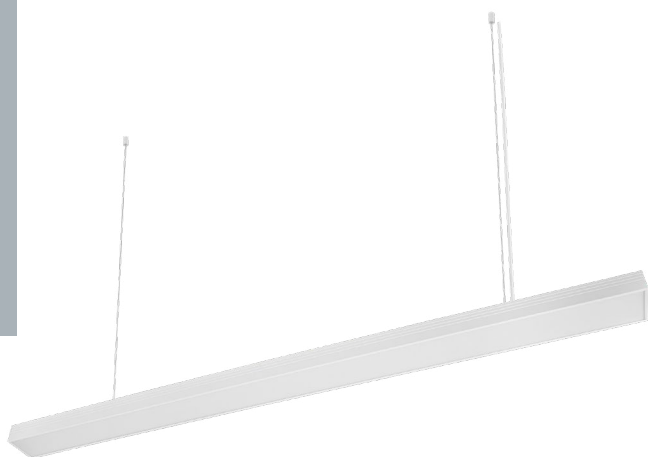

DG0712-LED 36W WH



Series	Pendant lights
LED	COB
CCT	6000K
CRI	RA ≥ 80
Power	36w
Luminous Flux	2880 Lm
Beam Angle	165 °
Color	White
Material	Aluminum
Size	L 1200 x W 100 x H1 50 x H 1000

797,00 грн.

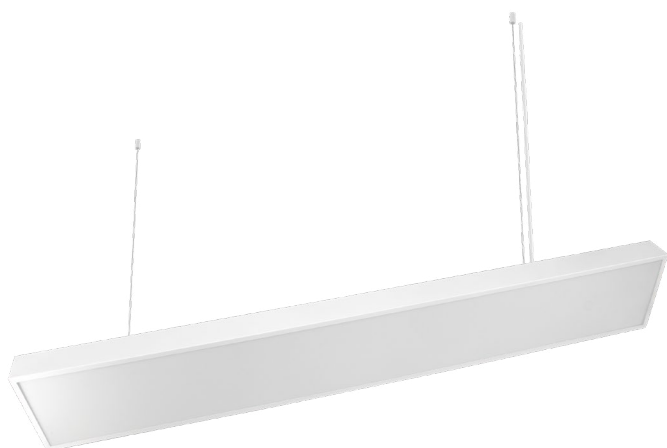

DG1812-LED 36W WH



Series	Pendant lights
LED	COB
CCT	6000K
CRI	RA ≥ 80
Power	36w
Luminous Flux	2880 Lm
Beam Angle	165 °
Color	White
Material	Steel
Size	L 1200 x W 180 x H1 50 x H 1000

1218,00 грн.

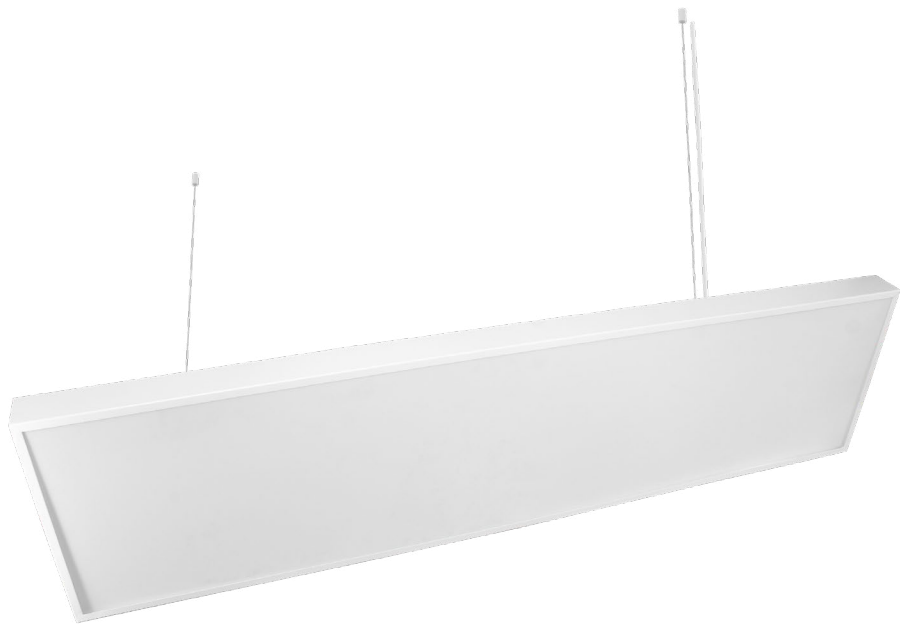

DG3012-LED 72w WH



Series	Pendant lights
LED	COB
CCT	6000K
CRI	RA ≥ 80
Power	72w
Luminous Flux	3840 Lm
Beam Angle	165 °
Color	White
Material	Steel
Size	L 1200 x W 295 x H1 50 x H 1000



1729,00 грн.



СПОТЫ

создают как равномерное, так и зональное освещение. Угол наклона светильника способен обеспечить узконаправленный свет, который помогает акцентировать внимание на конкретном предмете интерьера.

● **Spotlights**
series



TH5840 WH GU10

Series	Spotlight
Lamp	GU10 MAX 50W
Color	White
Material	Aluminum
Size	D 56 x H 140

**TH5840 BK GU10**

Series	Spotlight
Lamp	GU10 MAX 50W
Color	Black
Material	Aluminum
Size	D 56 x H 140





D208A-COB 7w WH

Series	Spotlight
LED	COB
CCT	3000K/4000K
CRI	RA ≥ 80
Power	7w
Luminous Flux	525 Lm
Beam Angle	24 °
Color	White
Material	Aluminum
Size	D 45 x H 175 x L 140



443,00 грн.

D208A-COB 7w WH+BK

Series	Spotlight
LED	COB
CCT	3000K/4000K
CRI	RA ≥ 80
Power	7w
Luminous Flux	525 Lm
Beam Angle	24 °
Color	White+Black
Material	Aluminum
Size	D 45 x H 175 x L 140



443,00 грн.

D208A-COB 7w BK

Series	Spotlight
LED	COB
CCT	3000K/4000K
CRI	RA ≥ 80
Power	7w
Luminous Flux	525 Lm
Beam Angle	24 °
Color	Black
Material	Aluminum
Size	D 45 x H 175 x L 140



443,00 грн.

D208B-COB 12W WH



Series	Spotlight
LED	COB
CCT	3000K/4000K
CRI	RA ≥ 80
Power	12w
Luminous Flux	900 Lm
Beam Angle	24 °
Color	White
Material	Aluminum
Size	D 55 x L 140 x H 173

601,00 грн.



D208B-COB 12W BK



Series	Spotlight
LED	COB
CCT	3000K/4000K
CRI	RA ≥ 80
Power	12w
Luminous Flux	900 Lm
Beam Angle	24 °
Color	Black
Material	Aluminum
Size	D 55 x L 140 x H 173

601,00 грн.



D209A-COB 7w WH

Series	Spotlight
LED	COB
CCT	3000K/4000K
CRI	RA ≥ 80
Power	7w
Luminous Flux	500 Lm
Beam Angle	24 °
Color	White
Material	Aluminum
Size	D 55 x L 91 x H 126

391,00 грн.

**D209A-COB 7w BK**

Series	Spotlight
LED	COB
CCT	3000K/4000K
CRI	RA ≥ 80
Power	7w
Luminous Flux	500 Lm
Beam Angle	24 °
Color	Black
Material	Aluminum
Size	D 55 x L 91 x H 126

391,00 грн.





D209B-COB 12w WH

Series	Spotlight
LED	COB
CCT	3000K/4000K
CRI	RA ≥ 80
Power	12w
Luminous Flux	900 Lm
Beam Angle	24 °
Color	White
Material	Aluminum
Size	D 65 x L 110 x H 145

496,00 грн.

**D209B-COB 12w BK**

Series	Spotlight
LED	COB
CCT	3000K/4000K
CRI	RA ≥ 80
Power	12w
Luminous Flux	900 Lm
Beam Angle	24 °
Color	Black
Material	Aluminum
Size	D 65 x L 110 x H 145

496,00 грн.



D209BL-COB 18w WH+BK



Series	Spotlight
LED	COB
CCT	3000K/4000K
CRI	RA ≥ 80
Power	18w
Luminous Flux	1350 Lm
Beam Angle	24 °
Color	White+Black
Material	Aluminum
Size	D 65 x H 220 x L 180



885,00 грн.

D209BL-COB 18w BK



Series	Spotlight
LED	COB
CCT	3000K/4000K
CRI	RA ≥ 80
Power	18w
Luminous Flux	1350 Lm
Beam Angle	24 °
Color	Black
Material	Aluminum
Size	D 65 x H 220 x L 180



885,00 грн.

TH8801 WH GU10

Series	Spotlight
Lamp	GU10 MAX 50W
Color	White
Material	Aluminum
Size	L 110 x W 70 x H 105



435,00 грн.

TH8801 BK GU10

Series	Spotlight
Lamp	GU10 MAX 50W
Color	Black
Material	Aluminum
Size	L 110 x W 70 x H 105



435,00 грн.

TH8802 WH 2XGU10



Series	Spotlight
Lamp	GU10 MAX 50W
Color	White
Material	Aluminum
Size	L 220 x W 70 x H 105



782,00 грн.

TH8802 BK 2XGU10



Series	Spotlight
Lamp	GU10 MAX 50W
Color	Black
Material	Aluminum
Size	L 220 x W 70 x H 105



782,00 грн.

TH8803 WH 3XGU10

Series	Spotlight
Lamp	GU10 MAX 50W
Color	White
Material	Aluminum
Size	L 350 x W 70 x H 103

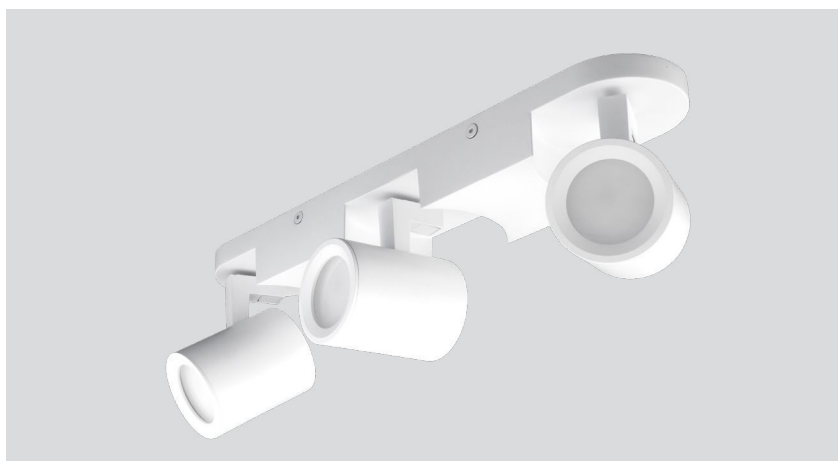

1253,00 грн.

TH8803 BK 3XGU10

Series	Spotlight
Lamp	GU10 MAX 50W
Color	Black
Material	Aluminum
Size	L 350 x W 70 x H 103



1253,00 грн.



TH8901 WH GU10

Series	Spotlight
Lamp	GU10 MAX 50W
Color	White
Material	Aluminum
Size	L 120 x W 60 x H 120



420,00 грн.

TH8901 BK GU10

Series	Spotlight
Lamp	GU10 MAX 50W
Color	Black
Material	Aluminum
Size	L 120 x W 60 x H 120



420,00 грн.

TH8902 WH 2XGU10



Series	Spotlight
Lamp	GU10 MAX 50W
Color	White
Material	Aluminum
Size	L 250 x W 60 x H 120



782,00 грн.

TH8902 BK 2XGU10



Series	Spotlight
Lamp	GU10 MAX 50W
Color	Black
Material	Aluminum
Size	L 250 x W 60 x H 120



782,00 грн.



ТРЕКОВЫЕ СВЕТИЛЬНИКИ

крепятся вертикально либо горизонтально на специальном шинопроводе. Высокий функционал и мобильность поворотного механизма светильника открывают огромный спектр возможностей создания любых сценариев освещения.

●

Track lights

series





391,00 грн.

TR8801 WH GU10



Series	Track lights
Lamp	GU10 MAX 50W
Color	White
Material	Aluminum
Size	D 58 x H 120



391,00 грн.

TR8801 BK GU10



Series	Track lights
Lamp	GU10 MAX 50W
Color	Black
Material	Aluminum
Size	D 58 x H 120



531,00 грн.

TR5840-L WH GU10



Series	Track lights
Lamp	GU10 MAX 50W
Color	White
Material	Aluminum
Size	D 56 x H 180



531,00 грн.

TR5840-L BK GU10



Series	Track lights
Lamp	GU10 MAX 50W
Color	Black
Material	Aluminum
Size	D 56 x H 180







516,00 грн.

H6204A-COB 7w WH+BK



Series	Track lights
LED	COB
CCT	3000K/4000K
CRI	RA ≥ 80
Power	7w
Luminous Flux	525 Lm
Beam Angle	24 °
Color	White+Black
Material	Aluminum
Size	D 55 x H 135 x L 90



516,00 грн.

H6204A-COB 7w BK



Series	Track lights
LED	COB
CCT	3000K/4000K
CRI	RA ≥ 80
Power	7w
Luminous Flux	525 Lm
Beam Angle	24 °
Color	Black
Material	Aluminum
Size	D 55 x H 135 x L 90





443,00 грн.

H208A-COB 7w WH



Series	Track lights
LED	COB
CCT	3000K/4000K
CRI	RA ≥ 80
Power	7w
Luminous Flux	500 Lm
Beam Angle	24 °
Color	White
Material	Aluminum
Size	D 45 x H 180 x L 140



443,00 грн.

H208A-COB 7w BK



Series	Track lights
LED	COB
CCT	3000K/4000K
CRI	RA ≥ 80
Power	7w
Luminous Flux	500 Lm
Beam Angle	24 °
Color	Black
Material	Aluminum
Size	D 45 x H 180 x L 140





601,00 грн.

H208B-COB 12W WH

Series	Track lights
LED	COB
CCT	3000K/4000K
CRI	RA ≥ 80
Power	12w
Luminous Flux	900 Lm
Beam Angle	24 °
Color	White
Material	Aluminum
Size	D 55 x H 180 x L 140



601,00 грн.

H208B-COB 12W BK

Series	Track lights
LED	COB
CCT	3000K/4000K
CRI	RA ≥ 80
Power	12w
Luminous Flux	900 Lm
Beam Angle	24 °
Color	Black
Material	Aluminum
Size	D 55 x H 180 x L 140

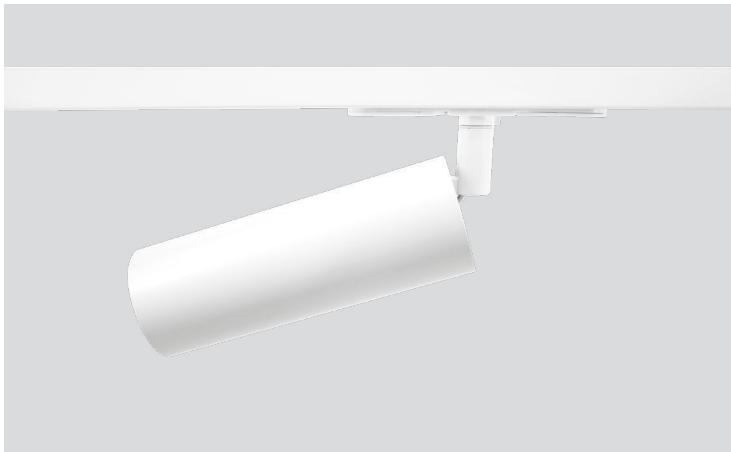

737,00 грн.

H208C-COB 18w WH



Series	Track lights
LED	COB
CCT	3000K/4000K
CRI	RA ≥ 80
Power	18w
Luminous Flux	1350 Lm
Beam Angle	24 °
Color	White
Material	Aluminum
Size	D 65 x H 225 x L 178



737,00 грн.

H208C-COB 18w BK

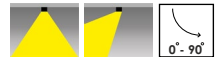

Series	Track lights
LED	COB
CCT	3000K/4000K
CRI	RA ≥ 80
Power	18w
Luminous Flux	1350 Lm
Beam Angle	24 °
Color	Black
Material	Aluminum
Size	D 65 x H 225 x L 178



391,00 грн.

H209A-COB 7W WH



Series	Track lights
LED	COB
CCT	3000K/4000K
CRI	RA ≥ 80
Power	7w
Luminous Flux	500 Lm
Beam Angle	24°
Color	White
Material	Aluminum
Size	D 55 x H 138 x L 90

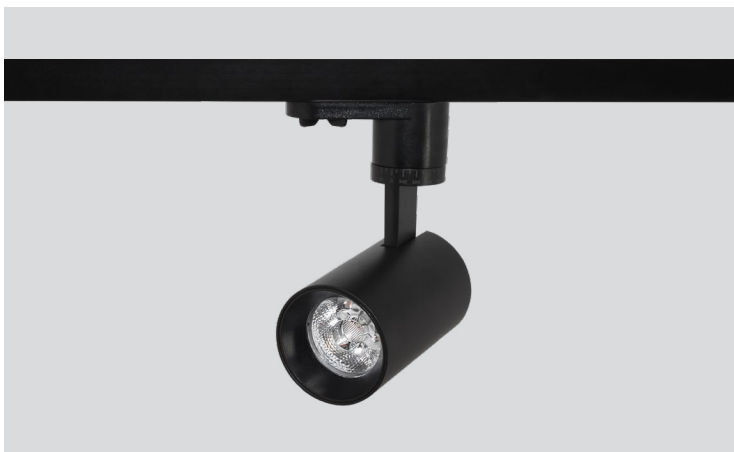

391,00 грн.

H209A-COB 7W BK



Series	Track lights
LED	COB
CCT	3000K/4000K
CRI	RA ≥ 80
Power	7w
Luminous Flux	500 Lm
Beam Angle	24°
Color	Black
Material	Aluminum
Size	D 55 x H 138 x L 90



421,00 грн.

H209A-COB 12w WH



Series	Track lights
LED	COB
CCT	3000K/4000K
CRI	RA ≥ 80
Power	12w
Luminous Flux	900 Lm
Beam Angle	24°
Color	White
Material	Aluminum
Size	D 55 x H 138 x L 90



421,00 грн.

H209A-COB 12w BK

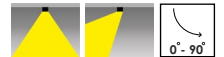

Series	Track lights
LED	COB
CCT	3000K/4000K
CRI	RA ≥ 80
Power	12w
Luminous Flux	900 Lm
Beam Angle	24°
Color	Black
Material	Aluminum
Size	D 55 x H 138 x L 90



617,00 грн.

H209AL-COB 12w WH

Series	Track lights
LED	COB
CCT	3000K/4000K
CRI	RA ≥ 80
Power	12w
Luminous Flux	900 Lm
Beam Angle	24 °
Color	White
Material	Aluminum
Size	D 55 x H 190 x L 140



617,00 грн.

H209AL-COB 12w BK

Series	Track lights
LED	COB
CCT	3000K/4000K
CRI	RA ≥ 80
Power	12w
Luminous Flux	900 Lm
Beam Angle	24 °
Color	Black
Material	Aluminum
Size	D 55 x H 190 x L 140



496,00 грн.

H209B-COB 12w WH



Series	Track lights
LED	COB
CCT	3000K/4000K
CRI	RA ≥ 80
Power	12w
Luminous Flux	900 Lm
Beam Angle	24 °
Color	White
Material	Aluminum
Size	D 65 x H 158 x L 110



496,00 грн.

H209B-COB 12w BK



Series	Track lights
LED	COB
CCT	3000K/4000K
CRI	RA ≥ 80
Power	12w
Luminous Flux	900 Lm
Beam Angle	24 °
Color	Black
Material	Aluminum
Size	D 65 x H 158 x L 110



664,00 грн.

H209B-COB 18w WH+BK



Series	Track lights
LED	COB
CCT	3000K/4000K
CRI	RA ≥ 80
Power	18w
Luminous Flux	1350 Lm
Beam Angle	24 °
Color	White+Black
Material	Aluminum
Size	D 65 x H 158 x L 110

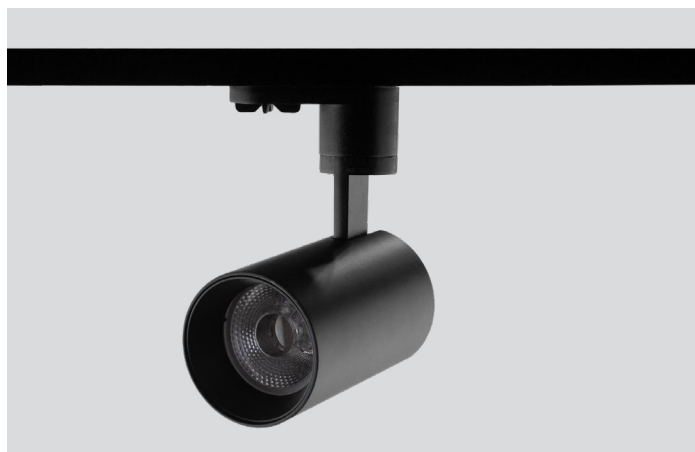

664,00 грн.

H209B-COB 18w BK



Series	Track lights
LED	COB
CCT	3000K/4000K
CRI	RA ≥ 80
Power	18w
Luminous Flux	1350 Lm
Beam Angle	24 °
Color	Black
Material	Aluminum
Size	D 65 x H 158 x L 110



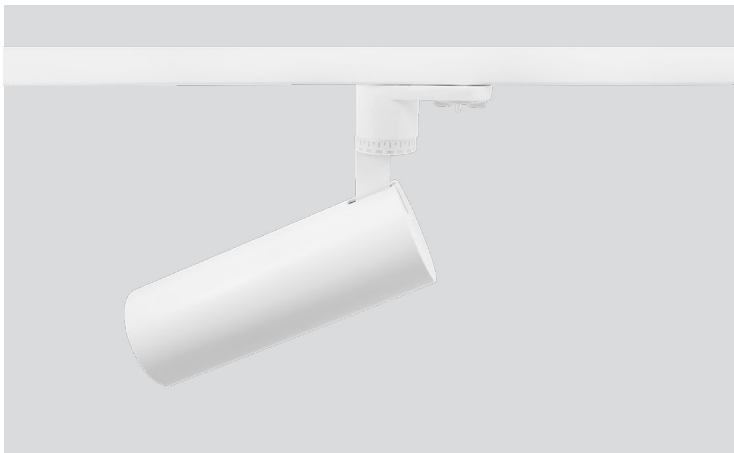

767,00 грн.

H209BL-COB 18w WH

Series	Track lights
LED	COB
CCT	3000K/4000K
CRI	RA ≥ 80
Power	18w
Luminous Flux	1350 Lm
Beam Angle	24 °
Color	White
Material	Aluminum
Size	D 65 x H 230 x L 180



767,00 грн.

H209BL-COB 18w BK

Series	Track lights
LED	COB
CCT	3000K/4000K
CRI	RA ≥ 80
Power	18w
Luminous Flux	1350 Lm
Beam Angle	24 °
Color	Black
Material	Aluminum
Size	D 65 x H 230 x L 180



697,00 грн.

H209C-COB 18w WH



Series	Track lights
LED	COB
CCT	3000K/4000K
CRI	RA ≥ 80
Power	18w
Luminous Flux	1350 Lm
Beam Angle	24 °
Color	White
Material	Aluminum
Size	D 75 x H 190 x L 130



697,00 грн.

H209C-COB 18w BK

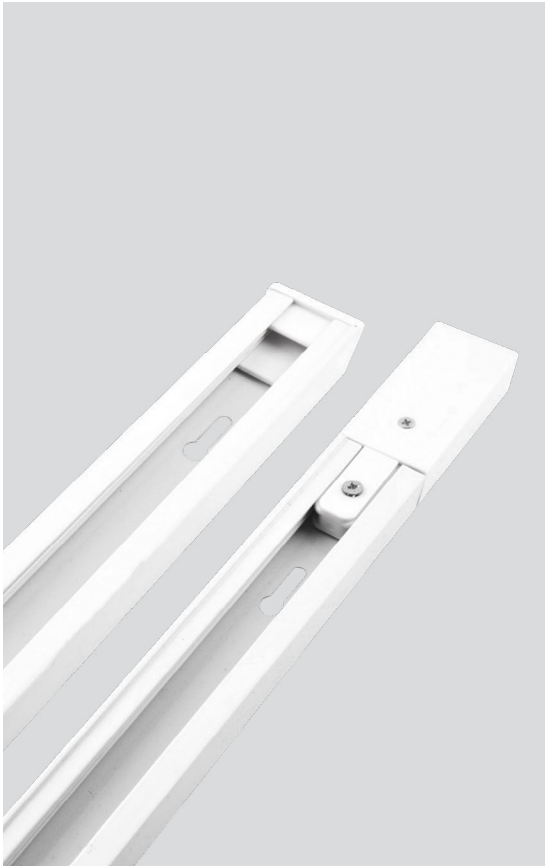

Series	Track lights
LED	COB
CCT	3000K/4000K
CRI	RA ≥ 80
Power	18w
Luminous Flux	1350 Lm
Beam Angle	24 °
Color	Black
Material	Aluminum
Size	D 75 x H 190 x L 130

**STR-10-1 WH**

192,00 грн.

Series	Track profile
Color	White
Material	Aluminum
Size	L 100 x W 35

STR-15-1 WH

288,00 грн.

Series	Track profile
Color	White
Material	Aluminum
Size	L 150 x W 35

STR-20-1 WH

384,00 грн.

Series	Track profile
Color	White
Material	Aluminum
Size	L 200 x W 35

1-PHASE TRACK**STR-10-11 BK**

192,00 грн.

Series	Track profile
Color	Black
Material	Aluminum
Size	L 100 x W 35

STR-15-11 BK

288,00 грн.

Series	Track profile
Color	Black
Material	Aluminum
Size	L 150 x W 35

STR-20-11 BK

384,00 грн.

Series	Track profile
Color	Black
Material	Aluminum
Size	L 200 x W 35

TRACK CONNECTORS



STR-2101-1 WH

Series	I-connector
Color	White
Material	Plastic / Metal
Size	L 105 x W 30



STR-2101-11 BK

Series	I-connector
Color	Black
Material	Plastic / Metal
Size	L 105 x W 30



STR-2102-1 WH

Series	L-connector
Color	White
Material	Plastic / Metal
Size	L 70 x W 70



STR-2102-11 BK

Series	L-connector
Color	Black
Material	Plastic / Metal
Size	L 70 x W 70



STR-2103-1 WH

Series	T-connector
Color	White
Material	Plastic / Metal
Size	L 105 x W 70



STR-2103-11 BK

Series	T-connector
Color	Black
Material	Plastic / Metal
Size	L 105 x W 70



STR-2104-1 WH

Series	X-connector
Color	White
Material	Plastic / Metal
Size	L 105 x W 105



STR-2104-11 BK

Series	X-connector
Color	Black
Material	Plastic / Metal
Size	L 105 x W 105

CABLE SYSTEMS FOR HANGING TRACK

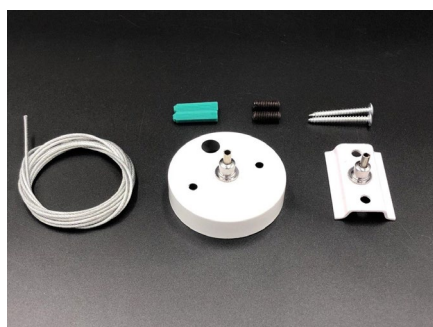

STR-2105-1

Series	Cable systems
Color	White
Material	Aluminum
Size	L 1000 x D 50



STR-2105-11

Series	Cable systems
Color	Black
Material	Aluminum
Size	L 1000 x D 50



H208A GD

Series	Track rings
Color	Gold
Material	Plastic
Size	D 45

46,00 грн.



съемные кольца на модели H208A, D208A

H208A CH

Series	Track rings
Color	Chrome
Material	Plastic
Size	D 45

46,00 грн.

H208B GD

Series	Track rings
Color	Gold
Material	Plastic
Size	D 55

54,00 грн.



съемные кольца на модели D208B, H208B, D209A, H209A, H209AL, H6204A

H208B CH

Series	Track rings
Color	Chrome
Material	Plastic
Size	D 55

54,00 грн.

H208B GD

Series	Track rings
Color	Gold
Material	Plastic
Size	D 65

62,00 грн.



съемные кольца на модели H208C, D209B, H209B, D209BL, H209BL

H208B CH

Series	Track rings
Color	Chrome
Material	Plastic
Size	D 65

62,00 грн.





НАСТЕННЫЕ СВЕТИЛЬНИКИ

могут являться как декоративным элементом или основным светом, так и применяться для акцентирования внимания на предмете интерьера. Серия светильников отличается лаконичностью, геометрией форм, высококачественным внутренним наполнением и высоким функционалом.

- **Wall lights**
series





WL1604 WH 2XGU10



Series	Wall lights
Lamp	GU10 MAX 50W
Color	White
Material	Aluminum
Size	W 75 x D 56 x H 180

413,00 грн.



WL1604 BK 2XGU10



Series	Wall lights
Lamp	GU10 MAX 50W
Color	Black
Material	Aluminum
Size	W 75 x D 56 x H 180

413,00 грн.





516,00 грн.

WL1606 WH 2XGU10

Series	Wall lights
Lamp	GU10 MAX 50W
Color	White
Material	Aluminum
Size	W 75 x D 70 x H 180



516,00 грн.

WL1606 BK 2XGU10

Series	Wall lights
Lamp	GU10 MAX 50W
Color	Black
Material	Aluminum
Size	W 75 x D 70 x H 180



WL1608 WH 2XGU10



Series	Wall lights
Lamp	GU10 MAX 50W
Color	White
Material	Aluminum
Size	W 75 x D 75 x H 220

590,00 грн.



WL1608 BK 2XGU10



Series	Wall lights
Lamp	GU10 MAX 50W
Color	Black
Material	Aluminum
Size	W 75 x D 75 x H 220

590,00 грн.

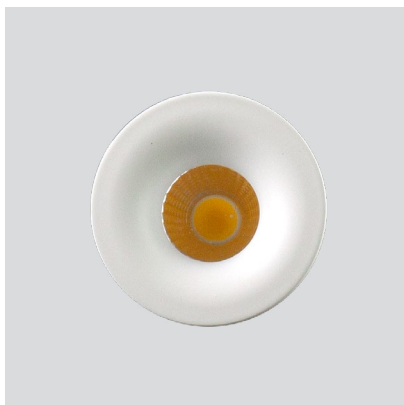

AK-732C-COB 3w WH

Series	Downlight
LED	COB
CCT	3000K
CRI	RA ≥ 80
Power	3w
Luminous Flux	240 Lm
Beam Angle	24 °
Color	White
Material	Aluminum
Size	D 48 x H 30

136,00 грн.

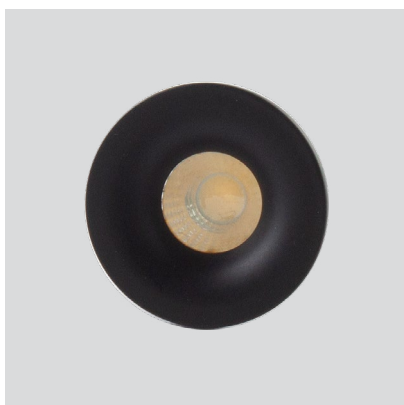

AK-732C-COB 3w BK

Series	Downlight
LED	COB
CCT	3000K
CRI	RA ≥ 80
Power	3w
Luminous Flux	240 Lm
Beam Angle	24 °
Color	Black
Material	Aluminum
Size	D 48 x H 30

136,00 грн.





УЛИЧНОЕ ОСВЕЩЕНИЕ

идеальный вариант локального освещения, который предназначен для размещения на открытом воздухе. Серия светильников наполнена самыми разнообразными моделями, что позволяет создавать эстетичные и высокотехнологичные сценарии освещения.

- **Outdoor**
lighting





OLP007-2815-COB 7W BK

Series	Outdoor
LED	COB
CCT	3000K
CRI	RA ≥ 70
Power	7w
Luminous Flux	420 Lm
Beam Angle	120 °
Color	Graphite
Material	Aluminum
Size	D 50 x H 130

549,00 грн.





OLP2207-COB 3W BK

Series	Outdoor
LED	COB
CCT	3000K
CRI	RA ≥ 80
Power	1x3w
Luminous Flux	180 Lm
Beam Angle	120 °
Color	Satin
Material	Steel
Size	D 51 x H 82

531,00 грн.



Схема монтажа



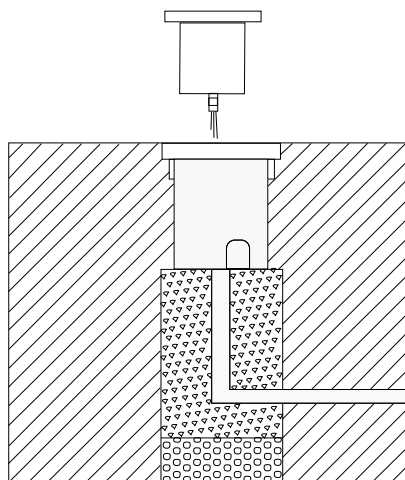
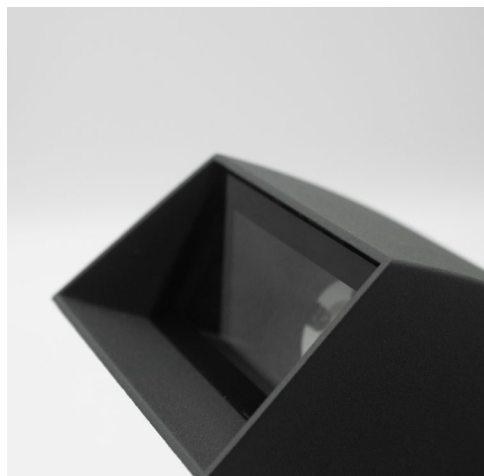

OLP2209-COB 1W+3W BK

Series	Outdoor wall light
LED	COB
CCT	3000K
CRI	RA ≥ 80
Power	1w+3w
Luminous Flux	240 Lm
Beam Angle	120°
Color	Graphite
Material	Aluminum
Size	H 170 x L 80 x W 47



513,00 грн.



OUTDOOR

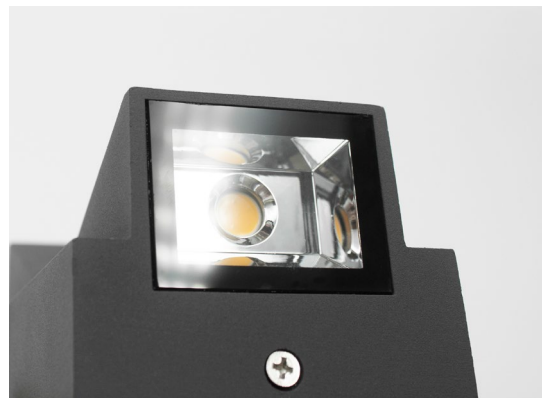

OLP2025-COB 3W+3W BK

Series	Outdoor wall light
LED	COB
CCT	3000K
CRI	RA ≥ 80
Power	2x3w
Luminous Flux	380 Lm
Beam Angle	120 °
Color	Graphite
Material	Aluminum
Size	L 82 x W 65 x H 147

585,00 грн.



OLP5012-COB 6W+6W BK

Series	Outdoor wall light
LED	COB
CCT	3000K
CRI	RA ≥ 80
Power	2x6w
Luminous Flux	720 Lm
Beam Angle	120°
Color	Graphite
Material	Aluminum
Size	D 57 x H 150 x W 80

641,00 ГРН.





OLP23703-COB 3W+3W BK

Series	Outdoor wall light
LED	SMD2835
CCT	3000K
CRI	RA ≥ 80
Power	2x3w
Luminous Flux	320 Lm
Beam Angle	120 °
Color	Graphite
Material	Aluminum
Size	L 105 x W 100 x H 133

823,00 ГРН.

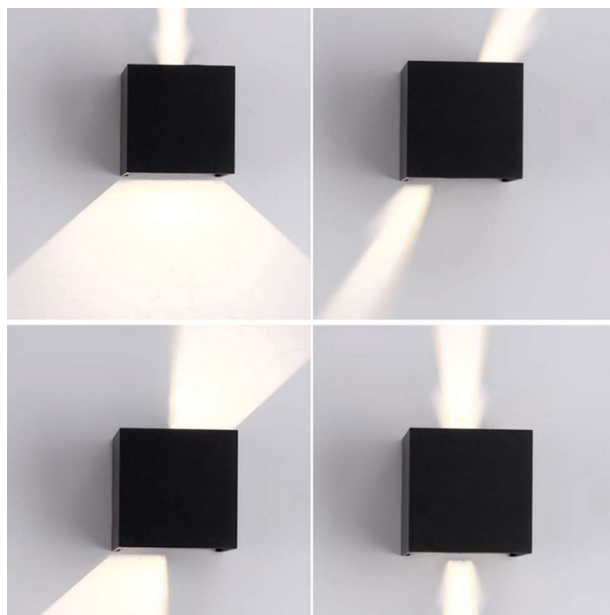





OLP2234-COB 6W+6W BK

Series	Outdoor wall light
LED	SMD2835
CCT	3000K
CRI	RA ≥ 80
Power	2x6w
Luminous Flux	700 Lm
Beam Angle	120 °
Color	Graphite
Material	Aluminum
Size	D 92 x H 132 x W 127

878,00 грн.







1032,00 грн.

SP29 BK-100w



Series	Floodlight
LED	SMD
CCT	6400K
CRI	RA ≥ 80
Power	100w
Luminous Flux	12000 Lm
Beam Angle	120°
Color	Black
Material	Aluminum
Size	D 300 x H 160



1327,00 грн.

SP29 BK-150w



Series	Floodlight
LED	SMD
CCT	6400K
CRI	RA ≥ 80
Power	150w
Luminous Flux	18000 Lm
Beam Angle	120°
Color	Black
Material	Aluminum
Size	D 355 x H 170



1622,00 грн.

SP29 BK-200w



Series	Floodlight
LED	SMD
CCT	6400K
CRI	RA ≥ 80
Power	200w
Luminous Flux	24000 Lm
Beam Angle	120°
Color	Black
Material	Aluminum
Size	D 400 x H 180





162,00 грн.

SP18 BK-10w



Series	Floodlight
LED	SMD
CCT	6400K
CRI	RA ≥ 80
Power	10w
Luminous Flux	800 Lm
Beam Angle	120 °
Color	Black
Material	Aluminum
Size	L 90 x W 70 x H 20



236,00 грн.

SP18 BK-20w



Series	Floodlight
LED	SMD
CCT	6400K
CRI	RA ≥ 80
Power	20w
Luminous Flux	1600 Lm
Beam Angle	120 °
Color	Black
Material	Aluminum
Size	L 143 x W 120 x H 25



339,00 грн.

SP18 BK-30w



Series	Floodlight
LED	SMD
CCT	6400K
CRI	RA ≥ 80
Power	30w
Luminous Flux	2400 Lm
Beam Angle	120 °
Color	Black
Material	Aluminum
Size	L 173 x W 150 x H 28



SP18 BK-50w

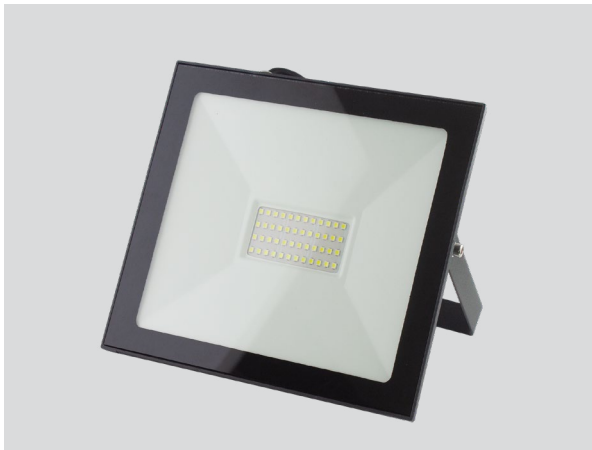

Series	Floodlight
LED	SMD
CCT	6400K
CRI	RA ≥ 80
Power	50w
Luminous Flux	4000 Lm
Beam Angle	120 °
Color	Black
Material	Aluminum
Size	L 215 x W 180 x H 30

487,00 грн.

SP18 BK-100w

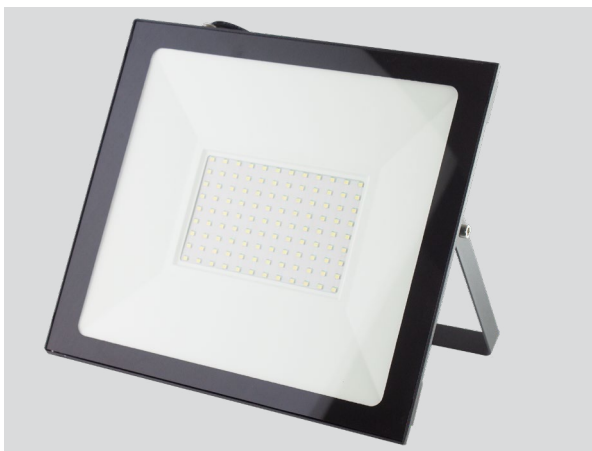

Series	Floodlight
LED	SMD
CCT	6400K
CRI	RA ≥ 80
Power	100w
Luminous Flux	8000 Lm
Beam Angle	120 °
Color	Black
Material	Aluminum
Size	L 287 x W 255 x H 30

796,00 грн.



Interior solution





LINEAR LIGHTING SYSTEM

Contents

01 LED strip

02 LED profile

03 Power supply



LED ЛЕНТА

успешно заменяет традиционные ламповые источники света. Она используется для основного освещения помещений. А так же для подсветки интерьеров и для уличного освещения. В транспорте, в витринах торговых помещений, для ландшафта и в качестве света для промышленных и складских зданий.



- **LED strip**
series



LED LV-2835-120

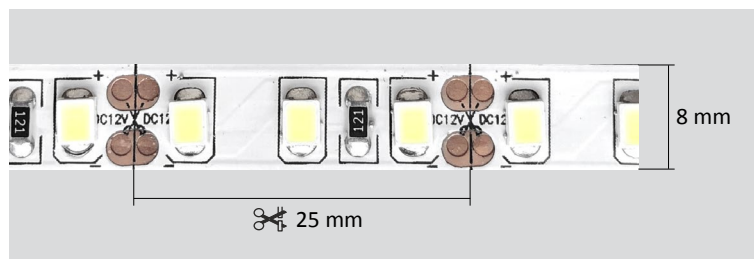

12V



14W

2400
Lm/mRA
≥ 85SMD
2835

66,00 грн. / м



5 m

Parameters

LED LV-2835-120 рекомендуется для освещения интерьеров домов, квартир, кафе, ресторанов, гостиниц. Размещается в нишах декоративной подсветки многоуровневых потолков либо в линейных светильниках изготовленных на основе алюминиевых профилей с рассеивающими линзами.

Series	Led strip
LED	SMD 2835
LED/m	120
CRI	RA ≥ 85
Power	14w
Luminous Flux	2400 Lm/m
Voltage	12V
IP	20

IP20

Code

Colour temperature

LED LV-2835-120 3000 K



Warm white 3000 K

LED LV-2835-120 4000 K



Neutral white 4000 K

LED LV-2835-120 6000 K



Cold white 6000 K

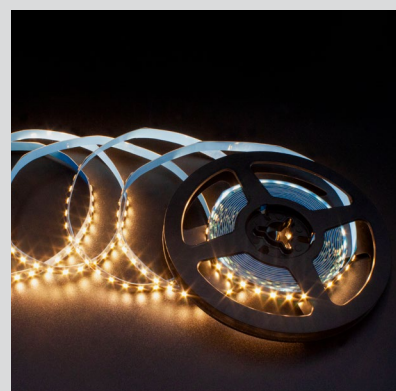

Warm white 3000 K



Neutral white 4000 K



Cold white 6000 K



LED LV-5050-60



12V

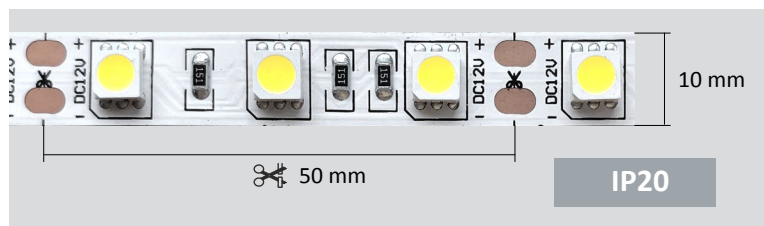

12W

960
Lm/mRA
≥ 85SMD
5050

81,00 грн. / м

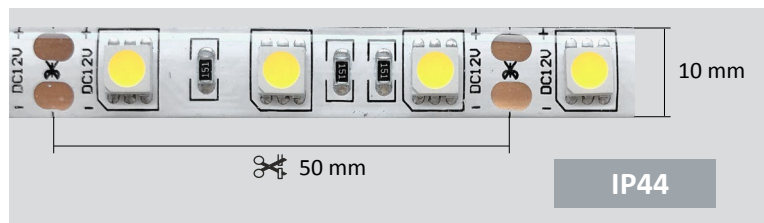

108,00 грн. / м



5 m

Parameters

LED LV-5050-60 рекомендуется для освещения интерьеров домов, квартир, кафе, ресторанов, гостиниц. Размещается в нишах декоративной подсветки многоуровневых потолков либо в линейных светильниках изготовленных на основе алюминиевых профилей с рассеивающими линзами.

Series	Led strip
LED	SMD 5050
LED/m	60
CRI	RA ≥ 80
Power	12W
Luminous Flux	960 Lm/m
Voltage	12V
IP	20/44



Warm white 3000 K



Neutral white 4000 K



Cold white 6000 K

IP20

Code

Colour temperature

LED LV-5050-60 3000 K		Warm white 3000 K
LED LV-5050-60 4000 K		Neutral white 4000 K
LED LV-5050-60 6000 K		Cold white 6000 K

IP44

Code

Colour temperature

LED LV-5050-60 IP44 3000 K		Warm white 3000 K
LED LV-5050-60 IP44 4000 K		Neutral white 4000 K
LED LV-5050-60 IP44 6000 K		Cold white 6000 K



LED WYJ-2835-120

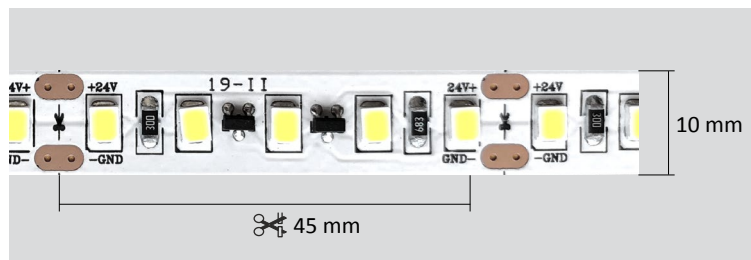

24V



12W

2800
Lm/mRA
≥ 85SMD
2835

192,00 грн. / м



20 m

Parameters

LED WYJ-2835-120 рекомендуется для освещения интерьеров домов, квартир, кафе, ресторанов, гостиниц. Размещается в нишах декоративной подсветки многоуровневых потолков либо в линейных светильниках изготовленных на основе алюминиевых профилей с рассеивающими линзами.

Series	Led strip
LED	SMD 2835
LED/m	120
CRI	RA ≥ 80
Power	12W
Luminous Flux	2800 Lm/m
Voltage	24V
IP	20

IP20

Code

Colour temperature

LED WYJ-2835-120 3000 K



Warm white 3000 K

LED WYJ-2835-120 4000 K



Neutral white 4000 K

LED WYJ-2835-120 6000 K



Cold white 6000 K



Warm white 3000 K



Neutral white 4000 K

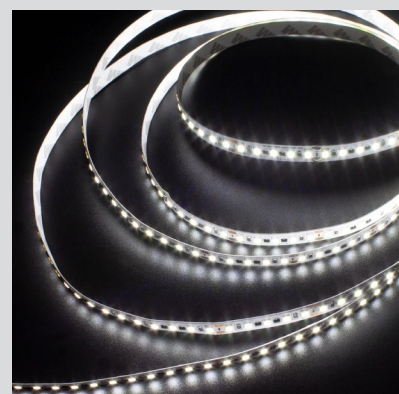

Cold white 6000 K



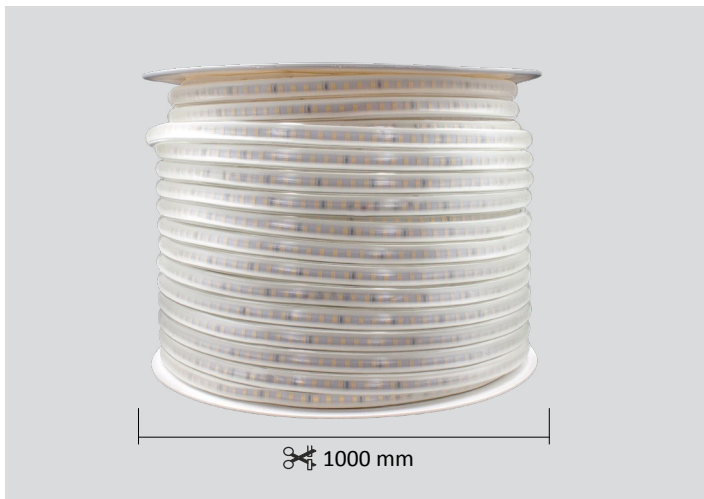

1000 mm



100 m

LED 2835-120-SL



220V



8W

2400
Lm/mRA
≥ 85SMD
2835

66,00 грн. / м

Parameters

LED 2835-120-SL рекомендуется для освещения интерьеров домов, квартир, кафе, ресторанов, гостиниц. Размещается в нишах декоративной подсветки многоуровневых потолков либо в линейных светильниках изготовленных на основе алюминиевых профилей с рассеивающими линзами.

Series	Led strip
LED	SMD 2835
LED/m	120
CRI	RA ≥ 85
Power	8W
Luminous Flux	2400 Lm/m
Voltage	220V
IP	65

IP65

Code

Colour temperature

LED 2835-120-SL 3000 K



Warm white 3000 K

LED 2835-120-SL 4000 K



Neutral white 4000 K

LED 2835-120-SL 6000 K



Cold white 6000 K

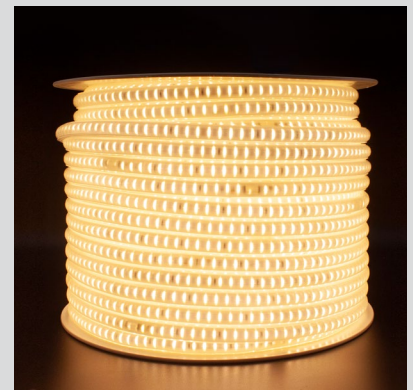

Warm white 3000 K



Neutral white 4000 K



Cold white 6000 K

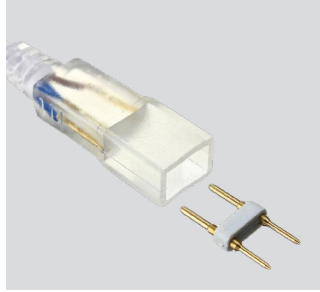
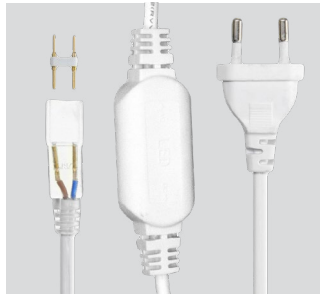
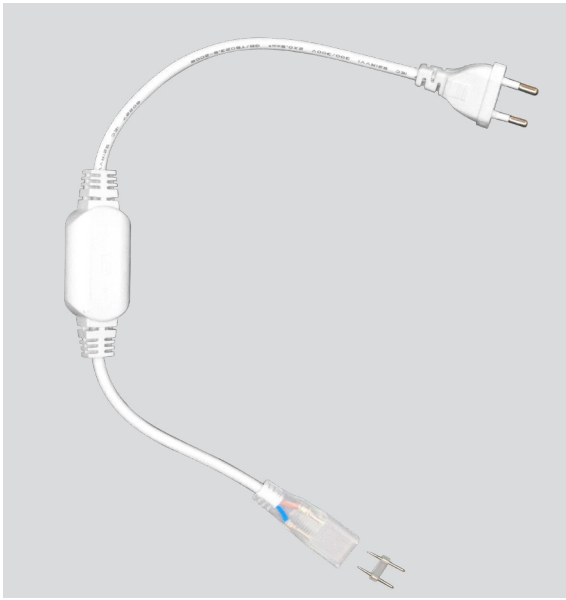

LED Plug-8A

Series	Led strip
Power	8A
Voltage	220V
Size	0,5 m

59,00 грн.



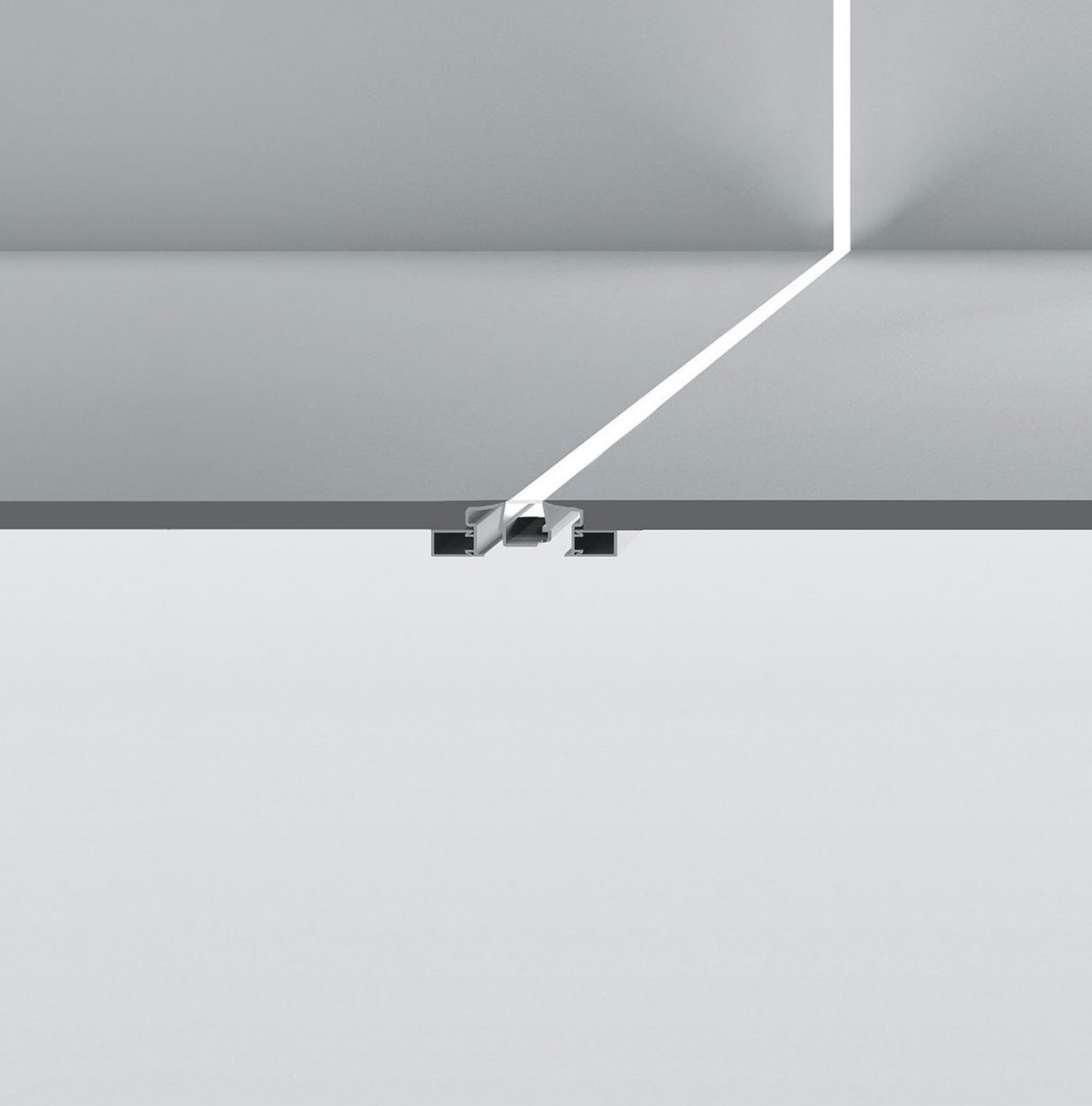

LED ПРОФИЛЬ

светодиодная лента в сочетании с LED профилем из алюминия представляет собой полноценный осветительный прибор. Такой способ установки обеспечивает длительный срок эксплуатации конструкции, за счет высокого защитного эффекта против механических повреждений. Форма профиля позволяет гармонично вписать конструкцию в любой дизайн помещения.

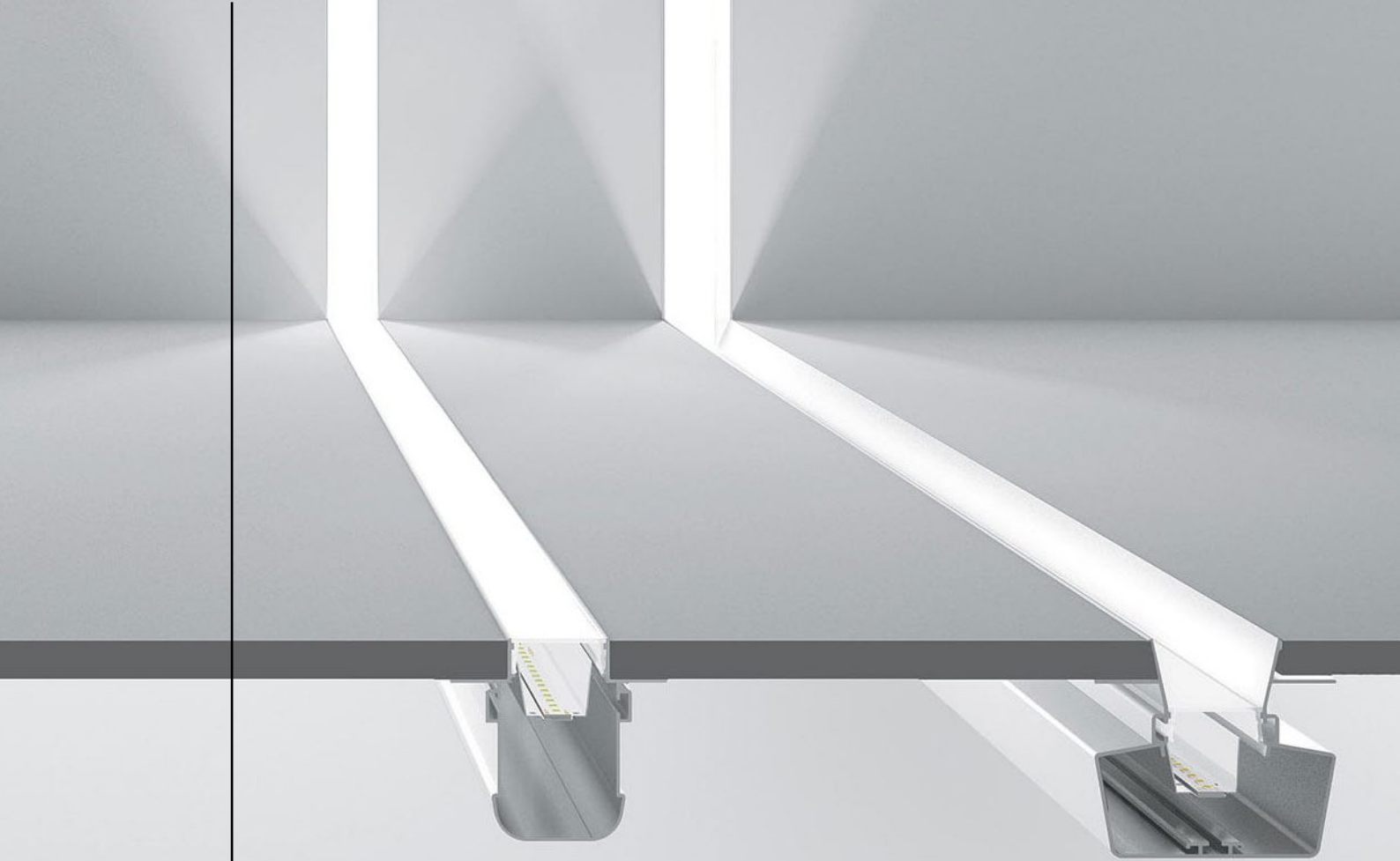

- **Led profile**
series



LED PXG-2040

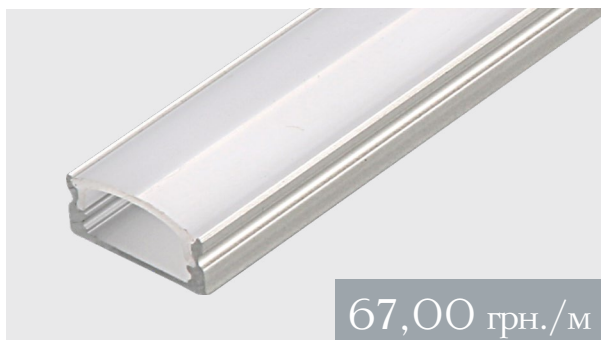
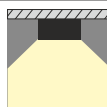
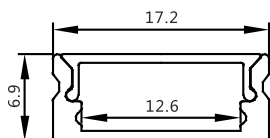

67,00 грн./м



Accessories

Series	Led profile
Material	Aluminum / Polycarbonate
Color	Silver / Opal
Size	17,2 x 12,6 x H 6,9
Maximum length	L= 3m

LED PXG-1204

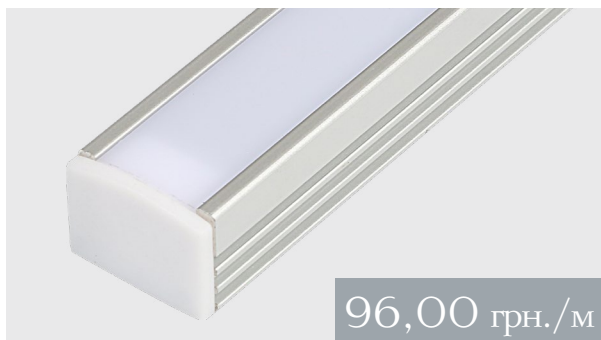
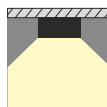
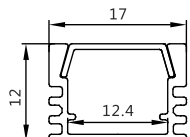

96,00 грн./м



Accessories

Series	Led profile
Material	Aluminum / Polycarbonate
Color	Silver / Opal
Size	17 x 12,4 x H 12
Maximum length	L= 3m

LED PXG-1203

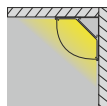
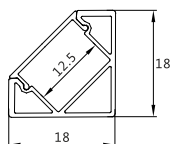

112,00 грн./м



Accessories

Series	Led profile
Material	Aluminum / Polycarbonate
Color	Silver / Opal
Size	12,5 x H 18 x H 2 18
Maximum length	L= 3m



LED PXG-3535-M

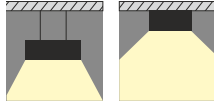
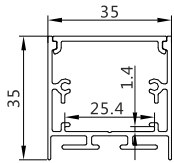

Accessories



413,00 грн./м

Series	Led profile
Material	Aluminum / Polycarbonate
Color	Silver / Opal
Size	l 35 x l 25,4 x H 35 x h 1,4
Maximum length	L= 3m

LED PXG-5575-M

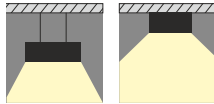
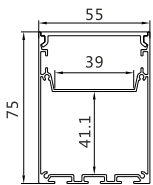

Accessories

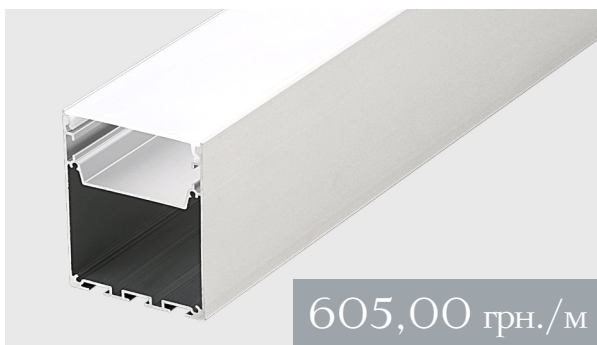

605,00 грн./м

Series	Led profile
Material	Aluminum / Polycarbonate
Color	Silver / Opal
Size	l 55 x l 39 x H 75 x h 41,1
Maximum length	L= 3m

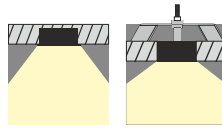
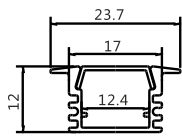

LED PXG-1204-A

103,00 грн./м

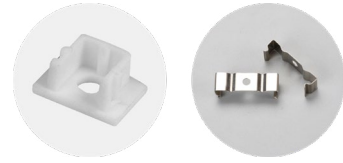

Accessories

Series	Led profile
Material	Aluminum / Polycarbonate
Color	Silver / Opal
Size	l 23,7 x l ₁ 12,4 x H 12 x l ₂ 17
Maximum length	L= 3m

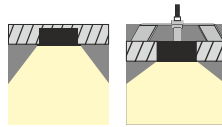
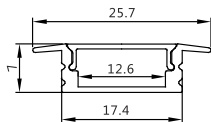
LED PXG-2050

74,00 грн./м



Accessories

Series	Led profile
Material	Aluminum / Polycarbonate
Color	Silver / Opal
Size	l 25,7 x l ₁ 12,6 x H 7 x l ₂ 17,4
Maximum length	L= 3m

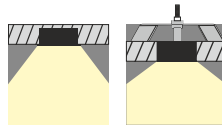
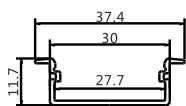
LED PXG-3010-A

185,00 грн./м

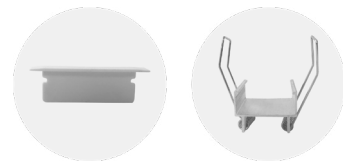

Accessories

Series	Led profile
Material	Aluminum / Polycarbonate
Color	Silver / Opal
Size	l 37,4 x l ₁ 27,7 x H 11,7 x l ₂ 30
Maximum length	L= 3m



LED PXG-5035-A

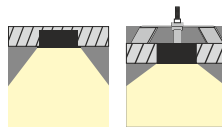
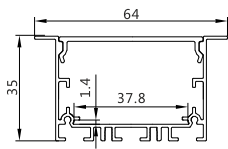

384,00 грн./м

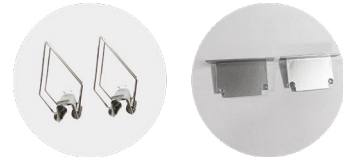

Accessories

Series	Led profile
Material	Aluminum / Polycarbonate
Color	Silver / Opal
Size	l 64 x l 1 37,8 x H 35
Maximum length	L= 3m

LED PXG-6613-A

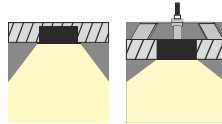
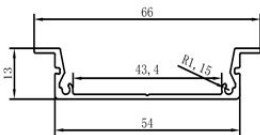

303,00 грн./м

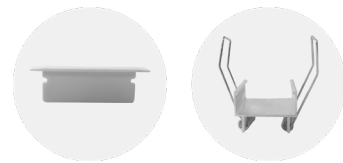

Accessories

Series	Led profile
Material	Aluminum / Polycarbonate
Color	Silver / Opal
Size	l 66 x l 1 43,4 x H 13 x l 2 54
Maximum length	L= 3m

LED PXG-7635-A

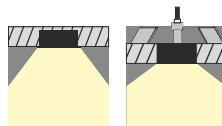
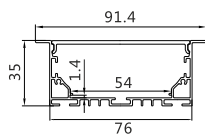

590,00 грн./м



Accessories

Series	Led profile
Material	Aluminum / Polycarbonate
Color	Silver / Opal
Size	l 91,4 x l 1 54 x H 35 x l 2 76
Maximum length	L= 3m



LINEAR LIGHTING SYSTEM





LED PXG-304

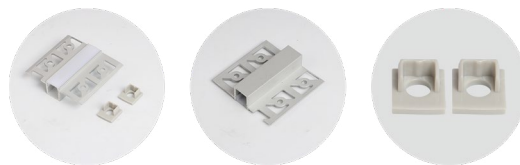
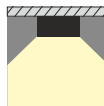
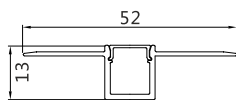

Accessories



Series	Led profile
Material	Aluminum / Polycarbonate
Color	Silver / Opal
Size	152 x 119 x H 13
Maximum length	L=4m

LED PXG-305

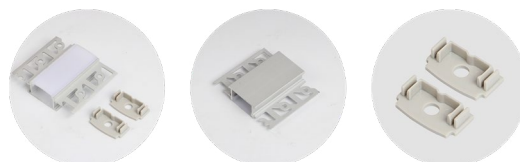
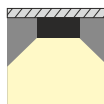
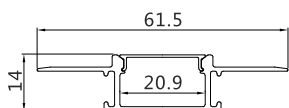

Accessories



Series	Led profile
Material	Aluminum / Polycarbonate
Color	Silver / Opal
Size	161,5 x 1120,9 x H 14
Maximum length	L= 3m

LED PXG-302

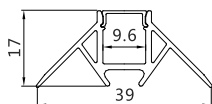

Accessories



Series	Led profile
Material	Aluminum / Polycarbonate
Color	Silver / Opal
Size	139 x 119,6 x H 17
Maximum length	L= 4m

LED PXG-303

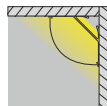
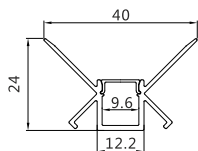

Accessories



Series	Led profile
Material	Aluminum / Polycarbonate
Color	Silver / Opal
Size	140 x 119,6 x H 24
Maximum length	L=4m

LED PXG-30

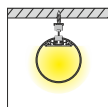
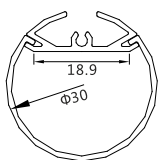

Accessories



Series	Led profile
Material	Aluminum / Polycarbonate
Color	Silver / Opal
Size	D 30 x l 18
Maximum length	L= 3m

LED PXG-60

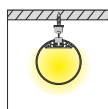
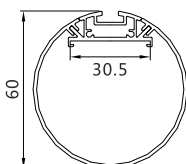

Accessories



Series	Led profile
Material	Aluminum / Polycarbonate
Color	Silver / Opal
Size	D 60 x l 30
Maximum length	L= 3m

Interior
solution



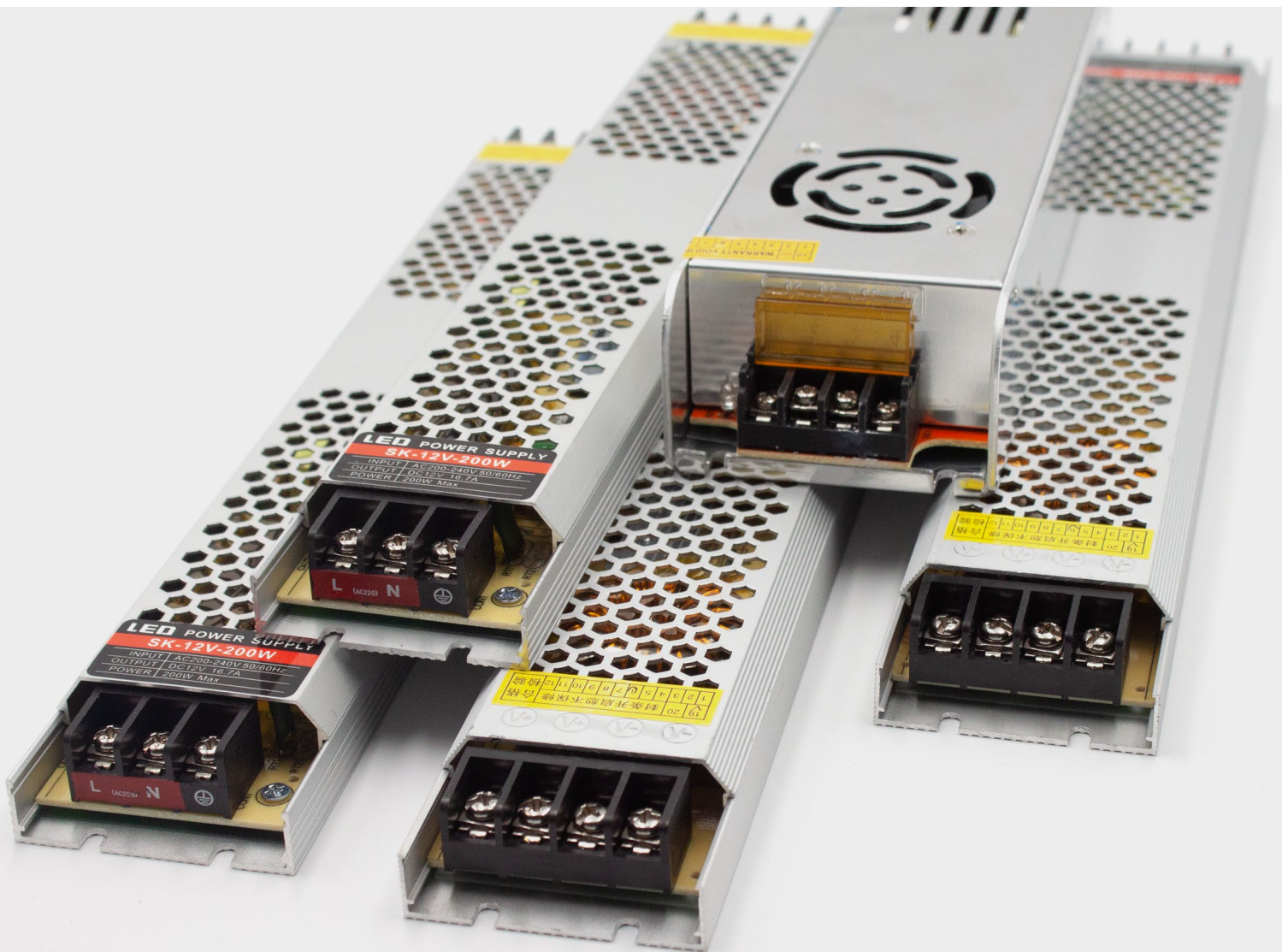

БЛОКИ ПИТАНИЯ

основная функция - снабжение светодиодов электрической энергией нужных параметров. Кроме того они стабилизируют напряжение и необходимы для выполнения определенных защитных функций. Позволяют увеличить срок эксплуатации светодиодных источников света, позволяя тем самым добиться максимальной производительности и эффективности работы всей системы.

Power supply
series



	Size	Weight	Power output	Output voltage	Output current	IP
LED PS60/12-IP20 369,00 грн.	L ₁ = 202 mm L ₂ = 53 mm H =21 mm	165 g	60W	12V	5A	IP20
LED PS150/12-IP20 516,00 грн.	L ₁ = 269 mm L ₂ = 53 mm H =21 mm	241 g	150W	12V	12,5A	IP20
LED PS200/12-IP20 545,00 грн.	L ₁ = 315 mm L ₂ = 53 mm H =21 mm	310 g	200W	12V	16,7A	IP20
LED PS300/12-IP20 560,00 грн.	L ₁ = 348 mm L ₂ = 53 mm H =21 mm	346 g	300W	12V	25A	IP20

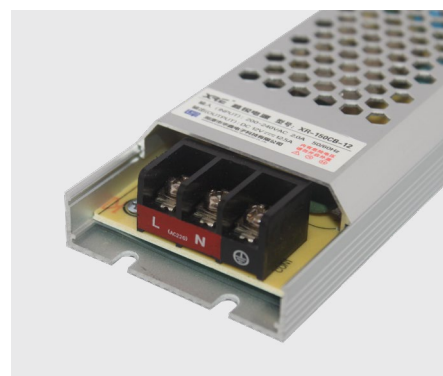

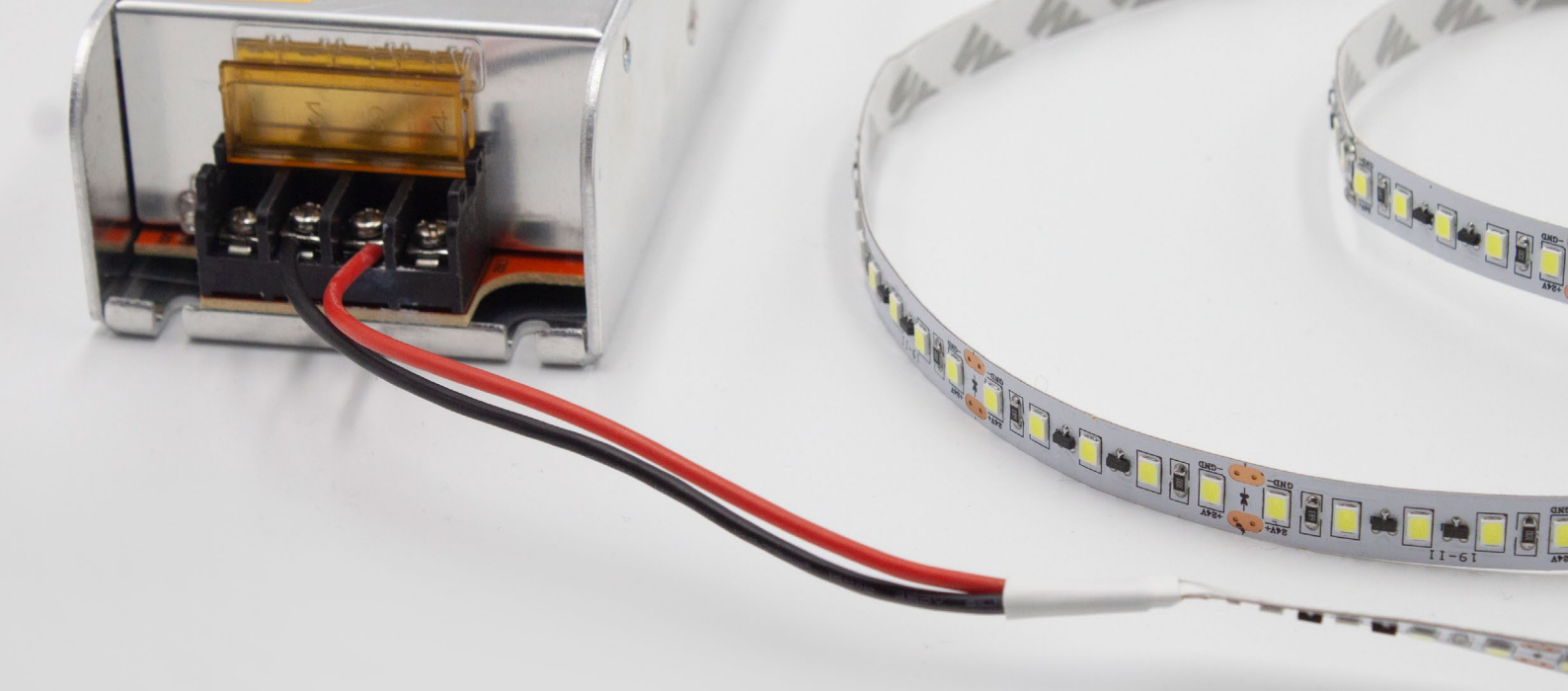

	Size	Weight	Power output	Output voltage	Output current	IP
LED PS360/24-IP20	L ₁ =225 mm L ₂ =68 mm H=40 mm	320 g	360W	24V	15A	IP20
	693,00 грн.					



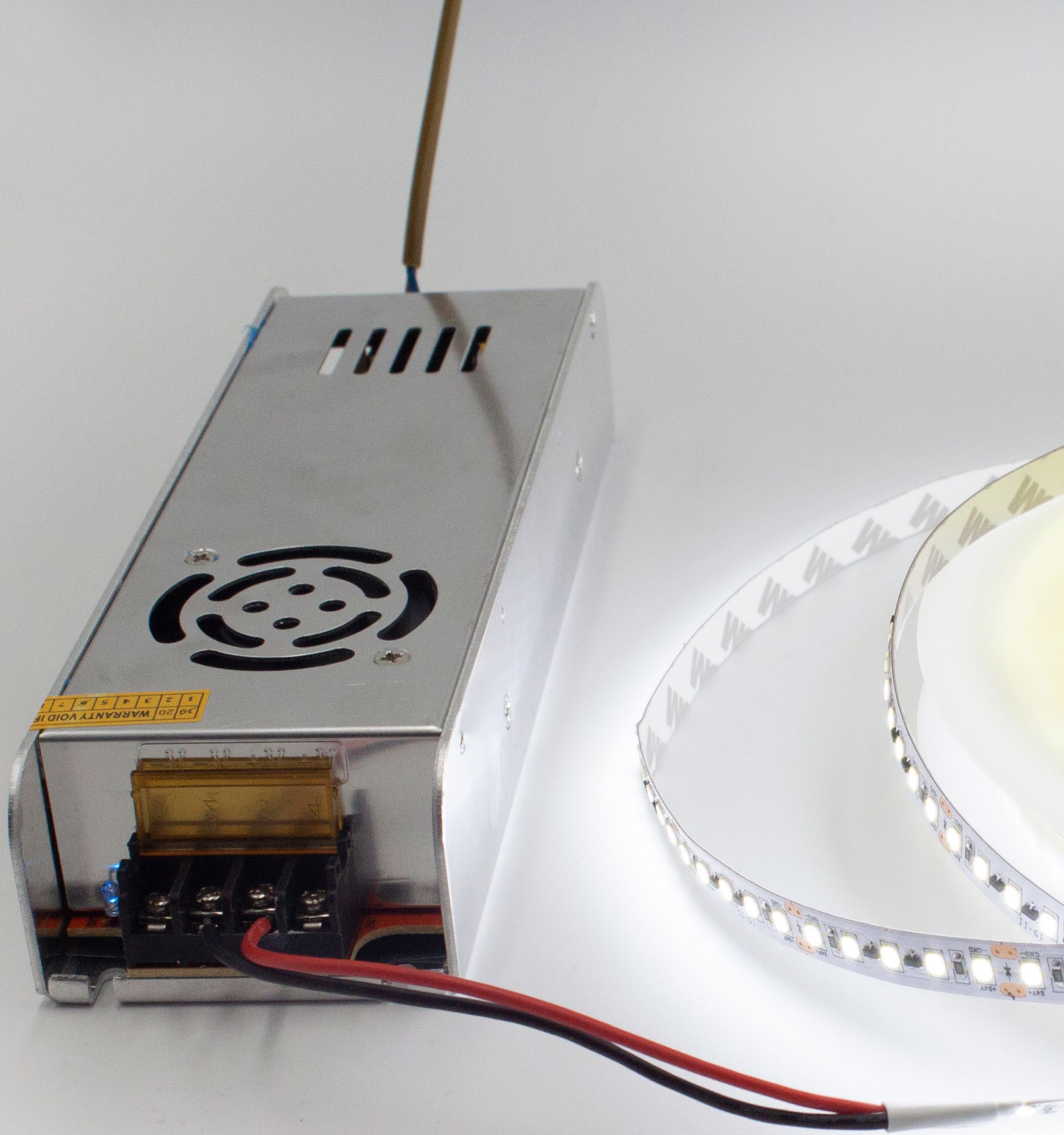

1 2 3 4 5 6 7
30 20 WARRANTY VOID IF

12V 1A

12V 1A

12V 1A

12V 1A

12V 1A

12V 1A

12V 1A

12V 1A

12V 1A

12V 1A

12V 1A

12V 1A

12V 1A

12V 1A

12V 1A

12V 1A

12V 1A





